

# MSA Latchways® Fall Protection



*Nobody Understands  
the Gravity of the  
Situation Better*



*Because every life has a **purpose...***



# Precisely Engineered Gravity Solutions

Designed to Protect  
Workers at Height

At-height experts delivering  
the best in fall protection

Established in 1974, Latchways has become a world-wide leading brand synonymous with engineering strength in fall protection. Maybe it's because we were the very first company to successfully develop and market engineered cable-based fall arrest systems. Or maybe it's because our constant innovations in worker safety at height have improved so many workplaces and lives.

One thing is certain: In a global industry with ever-evolving demands and ever-changing regulations, the call for fall protection that works with you and your specific needs has never been stronger.

That's why, in October 2015, Latchways joined forces with MSA Safety, Inc., a Pennsylvania-based Fortune 500 company with sales and manufacturing operations in more than 140 countries. Together, we bring unprecedented global leadership to protecting workers and satisfying customers around the world.



## CONTENTS

Introduction .....	4-11
Latchways Standard SRLs .....	12-13
Latchways Leading Edge SRLs .....	14-15
Latchways PFLs.....	16-19
<i>Latchways Single-Leg Mini PFLs.....</i>	<i>17</i>
<i>Latchways Twin-Leg Mini PFLs.....</i>	<i>18</i>
<i>Latchways 10-ft (3 m) PFLs.....</i>	<i>19</i>
Latchways Sealed SRLs .....	20-21
Latchways Sealed SRLs for Wind Energy .....	22-23
Latchways Sealed SRLs for Oil & Gas.....	24-25
Latchways Personal Rescue Device® .....	26-29
Latchways Solution for Windows.....	30-31
Latchways VersiRail® Guardrail Systems.....	32-37
Latchways Walksafe® Walkway Systems.....	38-41
Latchways Horizontal Lifelines (HLL) .....	42-47
Latchways Vertical Lifelines (VLL) .....	48-55
Latchways Inclined Systems.....	56-61
Latchways Solution for Aircraft—WinGrip® .....	62-67

## Global Leaders in Fall Protection

Because we provide customized fall protection solutions all around the world with our range of Latchways systems, MSA has a thorough understanding of any given country's safety concerns and needs. We have wide-ranging support, too, as our product leadership is backed by a worldwide network of highly trained registered installers and contractor companies.

And MSA is always thinking ahead—monitoring legislative developments around the world so that we can respond quickly with products and services designed to comply with new regulations without sacrificing productivity.

Simply put: MSA is fluent in the global language of fall protection.

No wonder our trusted systems and award-winning components can be found on structures as far away as Sydney's Harbour Bridge and as close by as Milwaukee's Miller Park Stadium.

### Premium fall protection solutions tailored to your project needs

MSA is comprehensive in its care and concern for those working at height. Our versatile fall protection systems—from roof to tower—offer solutions for nearly every work environment. Our experience working with so many different industries, from aerospace to tourism, means we have thorough knowledge of the particular fall protection needs specific to a variety of applications.

So tell us what you're looking for. With our Latchways range of smartly engineered systems and best-quality products, you're in the hands of experts.



### Commercial and Public Buildings

Imagine providing safe access without damaging roof integrity. Latchways horizontal and inclined systems, with their Constant Force® posts, do just that. We created systems like WalkSafe® to help further reduce wear and tear and LadderLatch™ to keep workers safe as they climb new heights.

### Transmission Towers, Distribution and Telecommunications

From towers to masts to monopoles, Latchways vertical systems can be seen protecting workers on transmission towers and distribution and telecommunication structures all over the world—even those in the most icy, rainy conditions.

### Bridges and Infrastructure

Each bridge and infrastructure project has different fall protection requirements. Latchways inclined, horizontal and vertical systems deliver unprecedented versatility, making it safe for workers to maintain canals, traverse bridge undersides, or safely access towers—no matter how harsh the conditions.

### Industrial Manufacturing

From overhead systems for above machinery operation to permanently installed lifelines, to temporary SRLs for one-off maintenance jobs, Latchways brings safety solutions to virtually any industrial manufacturing project. Our systems can link together horizontally, vertically and up inclines, and can be retrofitted or included as part of a new build.



## Oil and Gas

Our range of user-friendly safety solutions, from Latchways Self-Retracting Lifelines to Latchways Personal Rescue Device®, meet the demands of the oil and gas industry—and then some. With vertical, horizontal and inclined cable systems designed to follow complex contours found on rigs, pipe racks, gantries and more, we bring fall protection to the most severe environments.

## Wind Energy

From wind farm owners to maintenance contractors to global turbine manufacturers, wind energy professionals rely on innovations like our Latchways Sealed Self-Retracting Lifeline for safety and our TowerLatch™ unit for uninterrupted ladder ascension.



## Road and Rail

With time- and cost-saving options like Latchways Personal Rescue Device, Self-Retracting Lifeline and overhead cable systems, MSA keeps road and rail workers safe. Whether refurbishing stations, locomotives and loading trucks, or testing signals, you're on the right track with MSA.

## Stadiums and Tourism

The inherent flexibility of MSA horizontal, vertical and incline systems means fall protection is available to virtually any structure—from sports arenas like the Manchester Stadium to tourist attractions like the Orlando Eye.

## Aerospace

Working with aircraft engineers, MSA developed the easy-to-use Latchways WinGrip® system (for aircraft) to protect aerospace workers at height, without sacrificing productivity or quality. Among its many remarkable features, a WinGrip lifeline can span the length of any aircraft wing, allowing up to four workers access to all areas without ever disconnecting from the WinGrip lifeline. With the WinGrip AIO, flightline and hangar tasks become more efficient. Compact and lightweight, this self-contained vacuum anchor requires little setup or removal time. In addition, it's powered by a shop air supply or refillable gas cylinder that provides a minimum of six hours of stationary use. This is advanced technology at its best, able to perform in extreme hot or cold temperatures.

# Elevating the Science of Fall Protection

**Better science means better protection—it's that simple, really.**

No wonder MSA has been putting its resources, energy and smarts into the most cutting-edge technologies and most inspired breakthroughs with the Latchways range of products. We combine innovative technologies, best-in-class materials and advanced design to take fall protection to great new heights. The result is precisely engineered systems and components built for exceptional safety. Latchways systems are smartly designed for simple integration into nearly every work environment, bringing confidence to workers at height.

Latchways technologies that revolutionized the industry:



## Transfastener™

**Introduced 1982**

As much an engineering feat as it is a marvel of design, *the Latchways Transfastener holds the distinction of being fall protection's very first continuous attachment method.* Its signature "move" is ingenious—allowing its starwheel to continuously travel along the cable, thereby eliminating the need to detach and reattach when changing direction or crossing cable supports. Why use the two-snap hook method, with its risk for human error, when you can use the one patented component that allows you to move smoothly through your shift?



## Constant Force®

**Introduced 2001**

The unique principle behind much of our fall protection systems, Constant Force technology provides a consistent method of absorbing mechanical energy and controlling tension. *Latchways Constant Force post*, the industry's first top-fixing post, puts this principle into practice by deploying its integral energy-absorbing coil to methodically absorb the force generated in the event of a fall.



## WinGrip®

**Introduced 2004**

Quick to install and easy to use, Latchways WinGrip is a vacuum anchor fall protection system for use in aviation maintenance and aircraft manufacturing. Versatile in range and flexible in application, the modular designed WinGrip consists of four systems that can be used on fuselage, stabilizers, wings—and even beyond its traditional aerospace applications. *WinGrip is also the only solution that can be used inside and outside, and near open fuel tanks.*



Putting our products to the test each and every day

Every Latchways product is rigorously tested for strength, durability, functionality and integrity. Our mission is, and always will be, to bring you superior-quality merchandise that is both verified and trustworthy.

MSA ensures that all products are tested beyond the requirements of relevant legislative standards. We apply a minimum safety factor of 2, resulting in our products outperforming industry legislation.

Independent testing is carried out to externally verify the inherent quality and durability of Latchways systems. This also ensures complete compatibility between Latchways products and applications such as wind turbine tower internals.

By performing stricter-than-the-rest tests, MSA never misses an opportunity to earn your trust.



## Latchways Sealed SRL

**Introduced 2009**

Leave it to MSA to create the most tightly sealed SRL available, designed for the ultimate in fall protection when climbing in extreme environments. With Full Contact® pawls delivering a reliable locking mechanism that won't freeze, hang up or corrode, and game-changing field serviceable technology, *our sealed SRLs exceed quality standards, earning seals of approval from OSHA, ANSI and IP69K (where it receives the highest rating among similar products).*



## Latchways Personal Rescue Device®

**Introduced 2011**

The Latchways Personal Rescue Device (Latchways PRD®) is a game-changing integrated harness system that, in the event of a fall, lowers the user to the ground in a controlled descent. Because the device is worn as part of a standard harness, it saves time and cost—since no specialist training is required. Activate the device by simply pulling the parachute-style rip cord, which allows the spool and its integral braking mechanism to *lower the faller gently to safety in less than 30 seconds.*

# Fall Protection Designed by Us. Just for You.

With our dedicated in-house Design and Specification Team offering a number of free-of-charge services, MSA can assist you with your fall protection requirements.



## Design services—creating with your needs in mind.

**Design and Spec Service**—MSA's team of experts works with your AutoCAD roof plans or Building Information Modeling (BIM) files building elevations and sections to produce a complete fall protection system plan—integrated into your working files.

**Design Advice Service**—Here, our Design and Spec team assesses your own drawings featuring a fall protection layout and then offers advice and recommendations where necessary.

Simply choose whichever service suits you best, and we will provide you with a full Work-at-Height proposal to fulfill all your needs, all your legislative requirements, all within 10 working days.

**In-Person Consultation**—On more unusual projects that present different kinds of design challenges, it is sometimes easier to talk things through face-to-face. If you would prefer an in-person meeting, MSA will have a member of our team, or a representative from our network of Registered Installers, visit your offices to further discuss your specific design needs.

To take advantage of MSA's Design and Spec service, contact MSA at [spec@latchways.com](mailto:spec@latchways.com) or visit [latchways.com/spec-callback](http://latchways.com/spec-callback).

## What you can expect when you partner with us.

When you use our in-house Design and Specification team, you can expect us to design the most ideal fall protection system layout for your project.

We address all your needs, including:

- Assessing the risk
- Selecting the right system
- System applications
- User competency
- Product compatibility (with major roofing manufacturers, for example)
- Specifications (Master Format)
- Standard fixing details
- Design layout guidelines
- Alternative Latchways products to help meet your requirements

Our experts are proficient, so they can provide system designs for all applications, across all industries—from traditional horizontal systems used by construction to WinGrip® systems used by aerospace.

### BIM Portfolio and Resources

We're making it easier to integrate fall protection solutions into your BIM plans. With our portfolio of complex, intelligent BIM models, you can incorporate fall protection compliant with regulations to protect people working at height. Learn more and download resources at [latchways.com/bim-objects](http://latchways.com/bim-objects).







## MSA's Work-at-Height Proposal

MSA supplies all its customers with our Work-at-Height proposal—offering information and advice on how to provide a complete fall protection solution.

### The proposal includes:

- A full system design (using the information provided in the Design Questionnaire)
- Information on the Latchways product range and how they are fit for the purpose for which they are intended
- Guidance on planning for rescue should a fall occur

### Design Questionnaire

The completion of a Latchways Design Questionnaire enables us to specify a full design.

The questionnaire takes into account:

- Areas requiring access
- Construction of area requiring fall protection (e.g., roof material)
- Any known hazards

### Registered Installer Companies

MSA's Design and Specification service is supported by our global network of installer companies who play a full and proactive role in providing complete solutions for your chosen design—from installation and testing to certification and system maintenance.

## Accredited AEC Seminars

As much an educator as we are an industry pioneer, MSA offers an accredited AEC Daily seminar, "Fall Protection Systems: Selection, Specification, and Compliance," that provides an overview of fall protection.

### The 1.5 hour seminar covers topics including:

- Overview of fall protection
- The need for fall protection
- Fall arrest systems
- Fall protection standards and regulations

### The seminar provides:

- An understanding of the key considerations when specifying a fall protection system—ensuring compliance with legislation and a solution which is fit for purpose
- An overview of OSHA legislation
- Details on system choice and design
- An explanation of test standards
- Information on product differentiation
- Points to consider surrounding other work-at-height scenarios

**CONTACT MSA TODAY  
TO SCHEDULE A SEMINAR!**

# What's Your Fall Protection Plan?

**Employees who feel safe and protected when working at height bring confidence to their toughest jobs. That confidence translates into productivity. Productivity means less downtime, more cost savings.**

## Laws of Safety to Meet Laws of Gravity

In 1970, the Occupational Safety and Health Administration (OSHA) was created to enforce protective workplace safety and health standards.

OSHA requires companies provide fall protection at elevations of 4 ft (1.2 m) in general industry workplaces, 5 ft (1.5 m) in shipyards, 4 ft (1.2 m) in construction and 8 ft (2.4 m) in long-shoring operations. Other pre-requisites include implementing a fall protection and rescue plan, providing workers with

the right equipment for the job (including safety gear) and training employees on safe equipment use.

Observing these laws, along with implementing national consensus standards developed by ANSI, help protect ordinary at-height workers.

But MSA is no ordinary fall protection company. We don't just work to meet OSHA requirements and ANSI standards, we work to exceed them—on every level.

*Fall protection isn't just good for employees and business, it's also the law.*

## Hierarchy of Fall Protection

It's common sense, really: The hierarchy of fall protection starts by determining what type of fall protection system is truly required—and why.

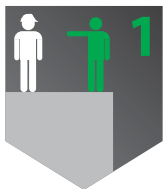

### Eliminate the Risk

Avoid working at height where possible or locate plant and equipment in safe locations where there's no risk of a fall. After all, if you're not at height, gravity has much less pull.



### Guard the Hazard

When working at height is essential, ensure that workers aren't exposed to unnecessary risks by providing a parapet or guardrail (such as Latchways VersiRail®) to eliminate fall hazards.

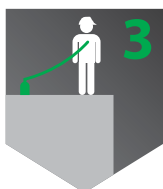

### Protect the worker

If it's not possible to eliminate the risk of falling, use the appropriate fall protection system to help minimize the consequences of a fall. This is achievable through either a fall arrest or fall restraint system.

"Fall restraint" and "fall arrest" are commonly used terms in the industry. Identifying the difference between the two is crucial in terms of understanding where and why a particular system should be used.

**Fall restraint** is useful when looking to prevent workers from reaching a point where a fall could happen. It's generally suited for persons who need to work at the edge of a hazard—for example, maintaining gutters along the edge of a roof.

**Fall arrest** comes into consideration when a worker can access a point at which a fall can occur. A fall arrest system will safely arrest a fall, which would then be followed by the appropriate rescue procedure.



## Service and Support in Response to Your Needs

---

**MSA supports and enhances your fall protection experience by delivering you the very best in individual attention along with first-class customer service.**

### Consultation

---

Thanks to our close working relationships with network providers and manufacturers across the globe, MSA is well positioned to offer expert support and advice on a range of working-at-height issues. These relationships also give MSA's unique insight into customers' individual requirements—and an unrivaled ability to satisfy them.

### Installation

---

Latchways systems can be installed only by our Registered Installers—experts who undergo rigorous training to ensure the safest installation.

### Training

---

Covering both installation and use of the system, MSA can conduct a training program at our Houston offices or at the customer's facility. We issue a certificate to all personnel who successfully complete the program.

Contact your MSA representative or visit [latchways.com](https://latchways.com) today.  
We look forward to putting your plan—and our partnership—in motion.

# Latchways Self-Retracting Lifelines

*Freedom.  
Security.  
Reinvented.*



## Latchways Standard SRLs

The Latchways Standard SRL has undergone extensive, independently verified testing to ensure consistent, reliable performance. Developed with unique features to provide a smarter, safer and stronger alternative to traditional SRLs, the Latchways Standard SRL is as versatile as it is flexible. Suitable for a wide range of applications, it's available with cable and webbing lanyards in four different lengths.

### Easy to service, even in the field

The Latchways SRL is easily recertified with just a few simple tools. Recertification can be performed locally by authorized representatives, or on site, ensuring the Latchways SRL has minimal time out of action.



### 1 Smarter

*Innovatively engineered with the revolutionary Constant Force frictionless braking system, it contains no moving parts and won't go out of adjustment.*

### 2 Safer

*Constantly moving, the 100% reliable Full Contact pawl locking mechanism cannot freeze, hang up or corrode. Every unit is fully tested in-house to exceed all required standards, even before being verified by independent external test houses.*

### 3 Stronger

*The rugged, impact-resistant case is manufactured from unique toughened nylon to protect the internal chassis from impact-based damage.*



### Latchways Standard SRL—Webbing

Model	Description	Line Type	Anchorage	Size (H x W x D)	Net Weight
62007-00US	23 ft (7 m) Webbing SRL	1" (25 mm) Polyester	Aluminum Snaphook	10 <sup>3</sup> / <sub>16</sub> x 7 <sup>7</sup> / <sub>16</sub> x 5" (275 x 186 x 127 mm)	9.6 lbs (4.4 kg)

### Latchways Standard SRL—Cable

Model	Description	Line Type	Anchorage	Size (H x W x D)	Net Weight
62207-00US	23 ft (7 m) (S/S) Cable SRL	Ø 3/16" (5mm) (S/S) Cable (7 x 19)	Forged Steel Snaphook	13 x 6 <sup>1</sup> / <sub>16</sub> x 4 <sup>1</sup> / <sub>16</sub> " (330 x 170 x 122 mm)	11.5 lbs (5.2 kg)
62407-00US	23 ft (7 m) (Galv) Cable SRL	Ø 3/16" (5mm) (Galv) Cable (7 x 19)	Forged Steel Snaphook	13 x 6 <sup>1</sup> / <sub>16</sub> x 4 <sup>1</sup> / <sub>16</sub> " (330 x 170 x 122 mm)	11.5 lbs (5.2 kg)
62210-00US	30 ft (9 m) (S/S) Cable SRL	Ø 3/16" (5mm) (S/S) Cable (7 x 19)	Forged Steel Snaphook	14 <sup>1</sup> / <sub>16</sub> x 7 <sup>7</sup> / <sub>16</sub> x 5" (357 x 186 x 127 mm)	13.2 lbs (6 kg)
62410-00US	30 ft (9 m) (Galv) Cable SRL	Ø 3/16" (5mm) (Galv) Cable (7 x 19)	Forged Steel Snaphook	14 <sup>1</sup> / <sub>16</sub> x 7 <sup>7</sup> / <sub>16</sub> x 5" (357 x 186 x 127 mm)	13.2 lbs (6 kg)
62215-00US	50 ft (15 m) (S/S) Cable SRL	Ø 3/16" (5mm) (S/S) Cable (7 x 19)	Forged Steel Snaphook	15 <sup>1</sup> / <sub>16</sub> x 8 <sup>8</sup> / <sub>16</sub> x 5 <sup>1</sup> / <sub>16</sub> " (395 x 214 x 130 mm)	16.6 lbs (7.5 kg)
62415-00US	50 ft (15 m) (Galv) Cable SRL	Ø 3/16" (5mm) (Galv) Cable (7 x 19)	Forged Steel Snaphook	15 <sup>1</sup> / <sub>16</sub> x 8 <sup>8</sup> / <sub>16</sub> x 5 <sup>1</sup> / <sub>16</sub> " (395 x 214 x 130 mm)	16.6 lbs (7.5 kg)

# Latchways Self-Retracting Lifelines

*The trusted SRL  
for work  
on the edge.*

## Latchways Leading Edge SRL

### Expansive mobility

With easy-to-use self-locking function, the Latchways Leading Edge SRL automatically extends and retracts during use for freedom to move over large working areas.

### Reliable technology

Latchways Leading Edge SRL features patented Constant Force® technology controls the load in the event of a fall; Full Contact™ locking mechanism helps to ensure that the device will not freeze, hang up or corrode.

### Versatile connection

Latchways Leading Edge SRL easily connects to many personal fall arrest systems for optimum compatibility with both vertical and horizontal applications.

### Strong and tested

Compliant with strict MSA quality-control procedures, the Latchways Leading Edge SRL features a toughened case to prevent impact damage, plus advanced premium quality materials for superior resistance to corrosion and abrasion. Additionally, Latchways Leading Edge SRLs are third-party-tested for contact with a 0.005" (0.13 mm) radius steel edge.

**The Latchways Leading Edge SRL has been tested to meet:**

- ANSI Z359.14



## Latchways Leading Edge SRL

The trusted self-retracting lifeline for work on the edge

**1 Energy absorption**

*Integral, in-line, patented Constant Force technology energy absorber methodically absorbs force generated in a fall and gives true deployment indication.*

**2 Manufacturer identification**

*Individually serial numbered to ensure full traceability.*

**3 Color safety**

*Bright yellow toughened case resists impact damage to protect internal chassis and to stand out when used at foot level to minimize trip hazard.*

**4 Thorough protection**

*Incorporates secondary unique shock pack to assist with energy absorption.*



## Materials

<b>CASE</b>	Impact modified nylon
<b>PAWL &amp; RATCHET MODULE</b>	Stainless steel
<b>CHASSIS</b>	Stainless steel
<b>MOTOR SPRING</b>	Stainless spring steel
<b>DRUM MODULE</b>	Aluminum
<b>FASTENERS</b>	Stainless steel
<b>CABLE</b>	Ø 0.25" (6 mm) 7 x 19 galvanized cable
<b>CF® ABSORBER MODULE</b>	Stainless steel and impact modified nylon
<b>SNAPHOOK</b>	Forged steel/stainless steel
<b>CONNECTING RING</b>	Aluminum
<b>SHOCK PACK</b>	Polyester webbing with neoprene cover

## Latchways Leading Edge SRL

Part Number	Description	Length	Line Type	Size (L x W x D)	Net Weight	Weight Capacity
62707-00US	23 ft (7 m) Leading Edge Cable SRL	23 ft (7 m)	Ø 0.25" (6 mm) 7 x 19 galvanized cable	36.5" x 7.3" x 5" (927 x 185 x 127 mm)	13.2 lb (6 kg)	310 lb (140 kg)
62710-00US	33 ft (10 m) Leading Edge Cable SRL	33 ft (10 m)	Ø 0.25" (6 mm) 7 x 19 galvanized cable	38" x 8.5" x 5" (965 x 216 x 127 mm)	17.6 lb (8 kg)	310 lb (140 kg)

# Latchways Self-Retracting Lifelines

*Impressive  
innovation in a  
compact size.*

## Latchways Single-Leg Mini, Twin-Leg Mini and 10-ft (3 m) PFLs

**Best suited for construction use, the Single-Leg 6-ft (1.8 m) Mini, Twin-Leg 6-ft (1.8 m) Mini and Latchways 10-ft (3 m) PFLs are designed specifically for environments where close anchorage is available.**

### Compact and Versatile

Latchways PFLs are the most compact and lightweight personal fall limiters ever developed, using multiple spring radial energy-absorbing technology. This new design eliminates the need for an external energy-absorber outside of the housing, making the units the most compact PFLs on the market.

### Reliable and Reassuring

The PFL's reinforced locking mechanism requires no additional lubrication—which could attract dirt and debris. The products offer fall arrest and restraint for users 130 to 400 lbs (60 to 181 kg) including tools.

### The world's first self-retracting lifeline with multiple spring radial energy absorbing technology

- Integral energy absorber
- Requires zero recalibration or adjustment
- Completely sealed from external contaminants
- Manufactured from lightweight stainless steel

### Strong and Tested

Latchways PFLs have a highly durable polycarbonate, clear casing which allows for easy visual inspection of the critical internal components. They can withstand temperatures ranging from -40° to +130° F (-40° to +54° C) and their high-performing, high-strength webbing lifelines have been manufactured to the highest standard in accordance to MSA's strict quality-control procedures. Latchways PFLs have been tested to meet these relevant standards:

- ANSI Z359.14 – 2012
- OSHA 1910.66
- OSHA 1926.502
- CSA Z259.2.2-98
- EN360: 2002



## Latchways PFLs

- 1 Unhindered use**  
*Fully rotating attachment point for completely unhindered use—both 360° and 180°*
- 2 Precision engineering**  
*A structurally reinforced pawl mechanism*
- 3 Highly durable**  
*A polycarbonate casing houses the PFL and its transparency allows for easy visual inspection of critical internal components*
- 4 Quality materials**  
*Components manufactured from high-grade stainless steel and engineered plastics*



# Latchways Single-Leg Mini PFL Connector Options

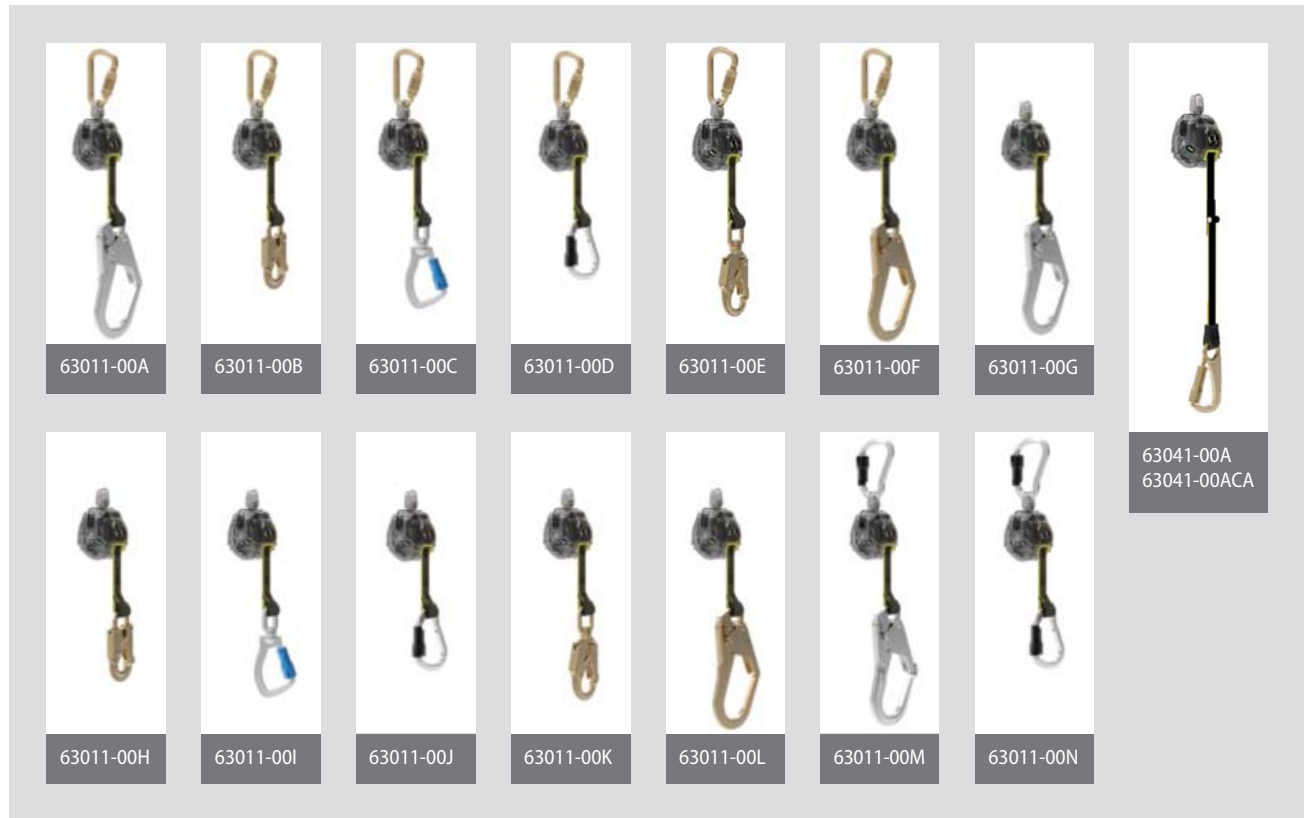

## Latchways Single-Leg Mini PFL

Part Number	Single-leg	Tie-Back	Length	Anchorage Connection	Harness Connection	ANSI	CSA	OSHA
63011-00A	■		6 ft. (1.8 m)	AL36CL	Steel carabiner	■	■	■
63011-00B	■		6 ft. (1.8 m)	36C	Steel carabiner	■	■	■
63011-00C	■		6 ft. (1.8 m)	Aluminum swivel carabiner	Steel carabiner	■	■	■
63011-00D	■		6 ft. (1.8 m)	Aluminum carabiner	Steel carabiner	■	■	■
63011-00E	■		6 ft. (1.8 m)	36CS	Steel carabiner	■	■	■
63011-00F	■		6 ft. (1.8 m)	36CL	Steel carabiner	■	■	■
63011-00G	■		6 ft. (1.8 m)	AL36CL	—	■	■	■
63011-00H	■		6 ft. (1.8 m)	36C	—	■	■	■
63011-00I	■		6 ft. (1.8 m)	Aluminum swivel carabiner	—	■	■	■
63011-00J	■		6 ft. (1.8 m)	Aluminum triple-lock carabiner	—	■	■	■
63011-00K	■		6 ft. (1.8 m)	36CS	—	■	■	■
63011-00L	■		6 ft. (1.8 m)	36CL	—	■	■	■
63011-00M	■		6 ft. (1.8 m)	AL36CL	Aluminum triple-lock carabiner	■	■	■
63011-00N	■		6 ft. (1.8 m)	Triple-lock carabiner	Triple-lock carabiner	■	■	■
63041-00A		■	9 ft. (2.7 m)	FP5K	Steel carabiner			■
63041-00ACA		■	9 ft. (2.7 m)	FP5K	Steel carabiner		■	■

# Latchways Twin-Leg Mini PFL Connector Options

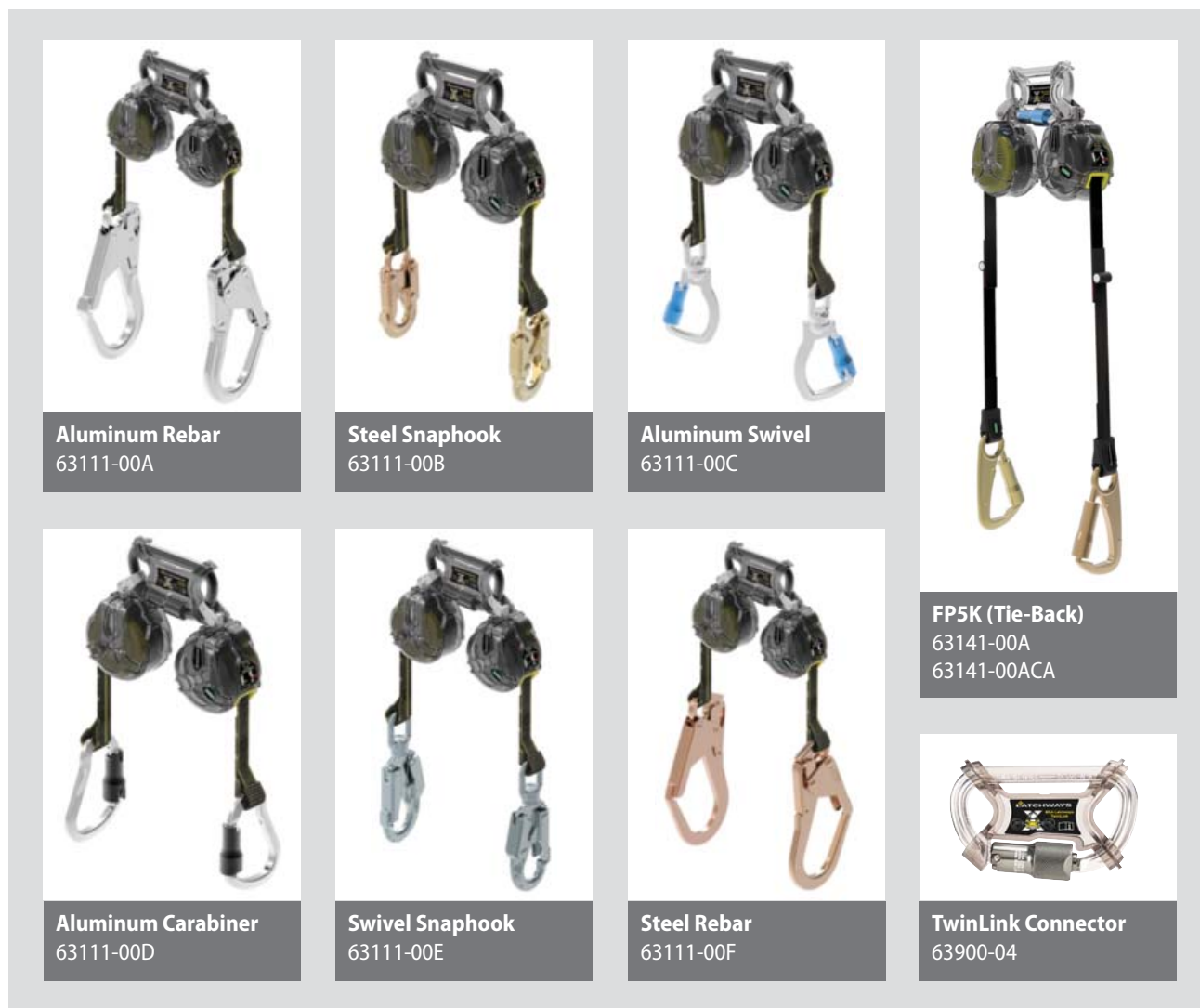

## Latchways Twin-Leg Mini PFL

Part Number	Twin-Leg	Tie-Back	Length	Anchorage Connection	Harness Connection	ANSI	CSA	OSHA
63111-00A	■		6 ft. (1.8 m)	AL36CL (2)	Twin-Link Connector	■	■	■
63111-00B	■		6 ft. (1.8 m)	36C (2)	Twin-Link Connector	■	■	■
63111-00C	■		6 ft. (1.8 m)	Aluminum swivel carabiner (2)	Twin-Link Connector	■	■	■
63111-00D	■		6 ft. (1.8 m)	Aluminum triple-lock carabiner (2)	Twin-Link Connector	■	■	■
63111-00E	■		6 ft. (1.8 m)	36CS (2)	Twin-Link Connector	■	■	■
63111-00F	■		6 ft. (1.8 m)	36CL (2)	Twin-Link Connector	■	■	■
63141-00A		■	9 ft. (2.7 m)	FPSK (2)	Twin-Link Connector			■
63141-00ACA		■	9 ft. (2.7 m)	FPSK (2)	Twin-Link Connector		■	■

63900-04 TwinLink Connector

# Latchways 10-ft (3 m) PFL Connector Options

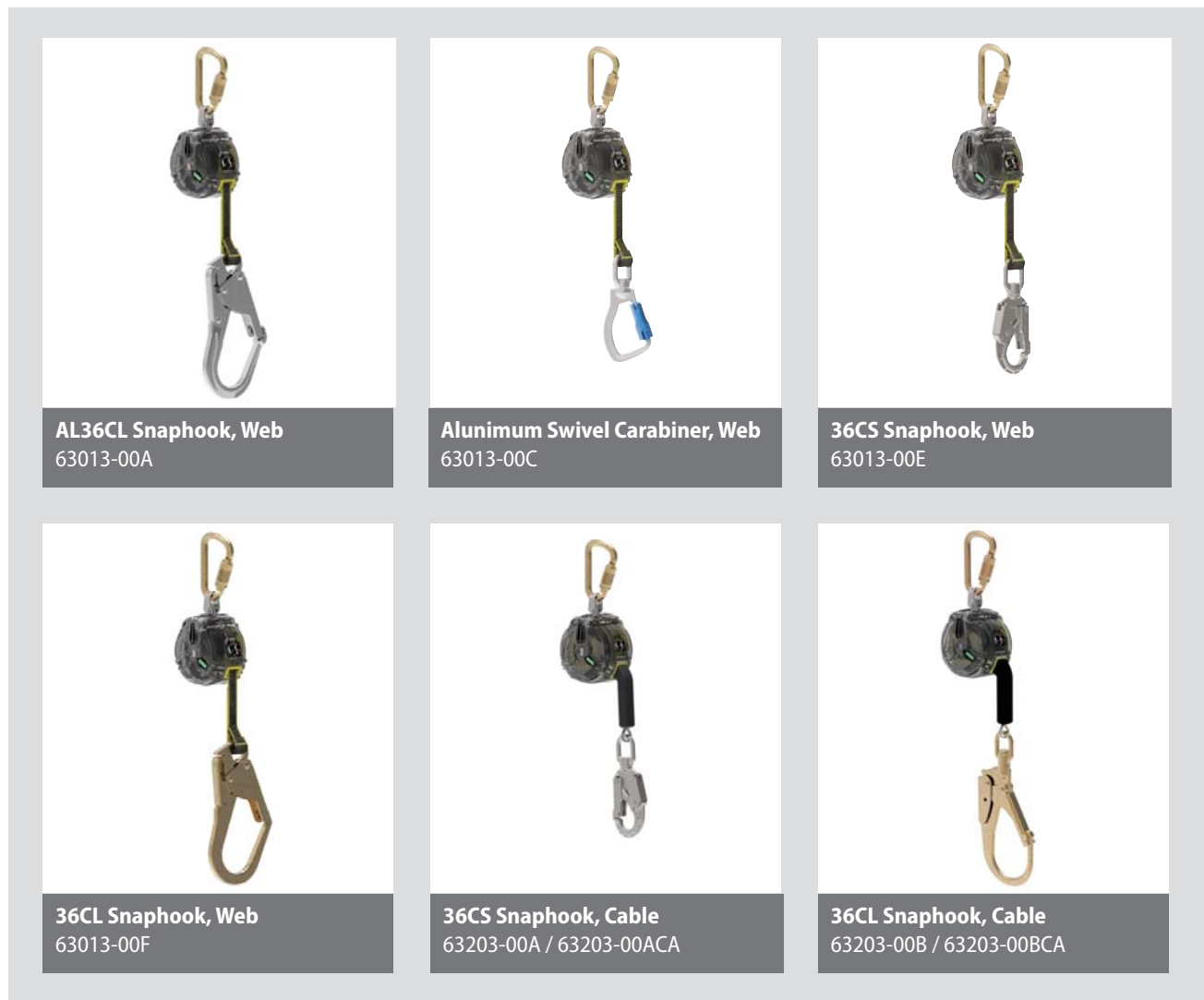

## Latchways 10-ft. (3 m) PFL

Part Number	Web	Cable	Length	Anchorage Connection	Harness Connection	ANSI	CSA	OSHA
63013-00A	■		10 ft. (3 m)	AL36CL	Steel carabiner	■	■	■
63013-00C	■		10 ft. (3 m)	Aluminum swivel carabiner	Steel carabiner	■	■	■
63013-00E	■		10 ft. (3 m)	36CS	Steel carabiner	■	■	■
63013-00F	■		10 ft. (3 m)	36CL	Steel carabiner	■	■	■
63203-00A		■	10 ft. (3 m)	36CS	Steel carabiner	■		■
63203-00B		■	10 ft. (3 m)	36CL	Steel carabiner	■		■
63203-00ACA		■	10 ft. (3 m)	36CS	Steel carabiner		■	■
63203-00BCA		■	10 ft. (3 m)	36CL	Steel carabiner		■	■

# Latchways Sealed Self-Retracting Lifelines

*Built for toughness.  
Bound for greatness.*



The Latchways Sealed SRL was designed for hands-free use in harsh environments such as oil rigs, wind turbines and other offshore applications, helping keep workers safe and focused on the task at hand.

Our Sealed SRL has undergone extensive, independently verified testing to ensure consistent, reliable performance.

With cutting-edge technology and engineering, the Latchways Sealed SRL is one of the most advanced and cost-effective SRLs on the market. Like our other SRLs, the Latchways Sealed SRL may be recertified on site by a Latchways-trained service technician, helping to lower the cost of ownership and provide a strong return on investment.



## Rigorously tested

### Ingress protection

With its verified “sealed status,” the Latchways Sealed SRL is the only product on the market that currently holds the IP69K Ingress Protection standard, ensuring individual components are dust tight and allowing high-pressure, high-temperature wash-down operations. Testing involved submersion to a 16.4 ft (5 m) depth, testing for ingress, and additional testing in a dust “suspension” for 8 hours to ensure no material ingress into critical components.

### Accelerated corrosion testing

To verify the Latchways Sealed SRL’s corrosion resistance, the product was subjected to accelerated corrosion, simulating real-life corrosion in a controlled environment—for 2,000 hours! This is a recognized representative period of 10 years “real-life” use of the Latchways Sealed SRL.

### High-vibration testing

The Latchways Sealed SRL underwent testing simulating an extreme high-vibration mechanical environment, subjecting it to levels considerably higher than any unit would encounter in typical use. To check the Latchways Sealed SRL’s integrity and stability of critical fasteners, samples were tested through a frequency range of 5 Hz to 1000 Hz for prolonged periods.

### ATEX assessment standards

The Latchways Sealed SRL was assessed to BS EN 13463-1:2001 and EN 13463-5:2003 equipment group II, category 2 (II 2 G c IIC T6) for use in areas in which explosive atmospheres (caused by mixtures of air and gases, vapors or mists, or by air/dust mixtures) are likely to occur.

### Independently tested

The Latchways sealed SRL is compliant with OSHA 1910.66, OSHA 1926.502, ANSI Z359.1-199 and ANSI Z 359.1-2007

## For Peace of Mind that Matters

Manufactured to confirm material compatibility and durability, each of our individual components undergoes strict quality-control procedures prior to assembly, including critical component batch x-ray to ensure product integrity.



### 1 For Advanced Technology in Action

*Traditional SRLs rely on friction braking systems that require re-tension, whereas MSA smarter energy absorption is frictionless. The Latchways Sealed SRL utilizes our patented Constant Force energy absorption to ensure consistent performance, so it won't go out of adjustment like other SRLs.*

### 2 For Protection that Doesn't Waiver

*Our Full Contact pawl locking mechanism provides locking that won't freeze, hang up or corrode. It also contains a built-in reserve line to ensure that a fall is arrested safely even when the cable is at its full limit.*

### 3 For Superior Ingress Protection

*To ensure the spring, locking mechanism and absorber are completely impenetrable to material and moisture ingress, the internal critical components are protected by rubber seals. IP69K rated.*

## Latchways Sealed SRL

Model	Line Type	Length	Size (L x W x D)	Weight	Anchorage
62810-00US	Ø 3/16" (5mm) (S/S) Cable (7 x 19)	30 ft (9 m)	10 1/2 x 9 1/2 x 7" (270 x 241 x 178 mm)	20.9 lbs (9.5 kg)	Forged/Stainless Steel Snaphook
62816-00US	Ø 3/16" (5mm) (S/S) Cable (7 x 19)	50 ft (15 m)	13 x 11 x 7 1/2" (330 x 279 x 191 mm)	26.5 lbs (12 kg)	Forged/Stainless Steel Snaphook
62826-00US	Ø 3/16" (5mm) (S/S) Cable (7 x 19)	85 ft (26 m)	13 x 13 x 7 1/2" (330 x 330 x 200 mm)	44.1 lbs (20 kg)	Forged/Stainless Steel Snaphook
62841-00US	Ø 3/16" (5mm) (S/S) Cable (7 x 19)	130 ft (40 m)	15 x 15 x 8 1/2" (381 x 381 x 216 mm)	57.3 lbs (26 kg)	Forged/Stainless Steel Snaphook

## Latchways Sealed Self-Retracting Lifelines for Wind Energy

*We put all  
our energy  
into your safety.*

Having serviced the wind energy industry for decades, MSA knows more than a thing or two about the power—and hazards—of harnessing the wind. As a result, we've put a great deal of our own power and resources behind creating one of the most expertly designed fall protection products in years: the Latchways Sealed SRL.

When combined with a fixed, custom-made anchor, this unique SRL offers powerful fall protection to workers climbing offshore wind turbine access ladders. Further, MSA engineers have the experience to work with the turbine foundation designers to incorporate the Latchways Sealed SRL during the manufacturing process. It's a marvel of dependable engineering designed to keep you safe and productive in the harshest conditions—and it's taking the wind energy industry by storm.

By this publication's date, MSA has supplied more than 4,000 Latchways Sealed SRLs to over 40 European wind farms. In the U.S., we continue expanding market share, having just recently supplied Latchways Sealed SRLs to locations off the coast of Rhode Island.





### The Complete Solution

With features like a weather-resistant locking mechanism and marine-grade polyester rope, the durable Latchways tether lines allow users to retrieve the offshore Latchways Sealed SRL user attachment eyelet from the top of a wind turbine ladder.



### Customer Focus



*"Nature is nature and it creates many unique issues with offshore wind farms. Every time a new turbine is installed there are new challenges to be overcome. Latchways is always open to looking at these issues and finding smart solutions. Our exceptionally close working relationship with their team helps us commission our wind turbines even more efficiently."*

**—Offshore logistics manager**

# Latchways Sealed Self-Retracting Lifelines for Oil and Gas

*Feel sure  
when you're  
offshore.*

With its ATEX assessment and IP69K rating, the Latchways Sealed SRL is more than capable of withstanding the harsh environments of the oil and gas industry. The Latchways Sealed SRL incorporates secondary retention features to prevent inadvertent loosening of fastening components of its primary anchor point.

In addition, secondary securing is possible through the use of a Latchways stainless steel wire rope strop to prevent the device from falling during installation or removal. Its utter versatility and inherent flexibility means our Sealed SRL can be installed on even the most complex structure, for unhindered hands-free fall protection.



## Latchways Sealed SRL

Best suited for offshore oil and gas use, the Sealed SRL is a fail-safe self-retracting lifeline featuring the Full Contact pawl locking mechanism that cannot hang up, freeze or corrode.



### Latchways Sealed SRL

Fit for a variety of purposes, such as undertaking drill pipe and collar handling duties on the monkey board, the Latchways Sealed SRL is an ideal fall protection solution—built for toughness, bound for greatness.



Explore this interactive oil rig at [latchways.com/oilgasrig](https://latchways.com/oilgasrig) to discover how Latchways can help keep oil and gas workers safe throughout the rig.

## Latchways Personal Rescue Device®

*A personal breakthrough in rescue solutions.*

**You're certainly not planning to, but what if when working at height you fall? And what if you were working alone and no one was there to help you? What do you do then? The answer is simple: You breathe a sigh of relief knowing that the Latchways Personal Rescue Device (Latchways PRD) puts safety and protection in your hands.**

Latchways PRD is a game-changing integrated harness system that, in the event of a fall, lowers the user to the ground in a controlled descent. It's a lightweight, unobtrusive rescue device contained in a small backpack attached to a full-body harness. Used in conjunction with a fall protection system or anchor point, the Latchways PRD allows you to go about your work, hands-free.

Because the device is worn as part of a standard harness, it saves both time and cost—since no special training is required. In the event of a fall, the Latchways PRD harness suspends users, then allows them to lower themselves by pulling the "rip cord," which, with its spool and integral braking mechanism, brings them safely to ground.



*The Latchways  
Personal Safety Device:  
**We've got your back.***

### Ease of Use

The PRD's patented components have been designed to fit neatly into the 'backpack' to ensure the worker can safely go about their daily work. The backpack zips onto the harness so that it becomes part of everyday wear for those who work at height. The harness is lightweight and unobtrusive but also robust, ensuring it can withstand the rigours of the harshest working environments.



**Latchways PRD  
EVOTECH®  
Full-body Harness**



**Latchways PRD  
EVOTECH Lite  
Full-body Harness**



**A stronger union.**

The Latchways PRD is compatible with a range of MSA Safety harnesses. Contact MSA for more information.

**Key Facts**

<b>DESCENT HEIGHT</b>	65 ft (20 m)
<b>COMPLETE WEIGHT</b>	7.9 lbs (3.6 kg) (2.2 lbs (1 kg) harness/5.7 lbs (2.6 kg) rescue device)
<b>USER WEIGHT</b>	130 – 310 lbs (59 – 140 kg)
<b>DESCENT SPEED</b>	4.1 ft (1.25 m) per second
<b>SECONDARY RELEASE MECHANISM</b>	Should the user not be able to rescue themselves, the device can be activated by a third party (see page 29)
<b>COMPONENT PARTS</b>	Descent line made from Aramid rope (UHMWPE rope with Aramid overbraid)
<b>TRAINING</b>	Minimal user training required—no annual user refresher training required
<b>MAINTENANCE</b>	Periodic examination limited to a series of visual inspections carried out by a competent person (full instructions provided)

**Latchways Personal Rescue Device, EVOTECH & EVOTECH Lite Harnesses**

PRD Part Number	Harness Type		Size		Line Length	Standards		
	EVOTECH	EVOTECH Lite	STD	XLG		ANSI Z359	CSA Z259	OSHA
10176307	■		■		65 ft (20 m)	■	■	■
10176308	■			■	65 ft (20 m)	■	■	■
10176309		■	■		65 ft (20 m)	■	■	■
10176310		■		■	65 ft (20 m)	■	■	■

# Latchways Personal Rescue Device



## Fall Protection in a Flash

When working at height near energized electrical sources, companies and their employees put themselves at risk. No matter what structure you are accessing, a Latchways Arc Flash PRD® provides an extra level of safety following a fall caused by electric arc flash or arc-blast exposure.



**Latchways PRD  
EVOTECH Arc Flash  
Full-body Harness**



## Latchways Arc Flash PRD

Arc flashes can produce high-pressure blasts and temperatures up to 35,000° F (19,427° C). The Latchways Arc Flash PRD is designed to protect workers at height from just such an event. With fire-resistant webbing and moisture-wicking padding, our Arc Flash PRD makes for easy inspection and comfortable, durable, all-shift wear.

## Latchways Personal Rescue Device, Arc Flash Harness

PRD Part Number	Size		Line Length	Standards		
	STD	XLG		ANSI Z359	CSA Z259	OSHA
10176311	■		65 ft (20 m)	■		■
10176312		■	65 ft (20 m)	■		■



## Rescue Pole

The Latchways Rescue Pole is designed to be used by a third party. Should the user be unable to conduct a self-rescue, the third party can activate the Latchways PRD's built-in secondary descent release mechanism. The overall length of the pole is 2.7 ft (0.8 m) when retracted and 11.1 ft (3.4 m) when extended.

**PRD RESCUE POLE** 68099-00

## Case Study

Street CraneXpress | United Kingdom



How can we protect our workers while still serving our customers?

*Street CraneXpress, one of the UK's foremost providers of crane maintenance, inspection and repairs, posed this question to Latchways. The answer was clear—the Latchways Personal Rescue Device. Here are a few reasons why:*

*The Latchways PRD is self-operated, so Street CraneXpress workers can lower themselves gently to the ground without involving or endangering other people in carrying out a rescue.*

*If a Street CraneXpress worker fell and was left both suspended and unconscious, Latchways provides a rescue pole so another worker can operate the Latchways PRD's safety mechanism and lower their coworker to safety.*

*Last, because the Latchways PRD is so simple to use, Street CraneXpress can save themselves financial and productivity setbacks by eliminating expensive, time-consuming training courses that detract from getting the job done.*

**For Street CraneXpress, keeping their at-height workers safe while keeping their customers satisfied was a tricky needle to thread. The reliable, cost-effective, Latchways PRD struck that balance—with confidence to spare.**

## Latchways for Windows

*Window  
washing  
made secure.*

Look up at any skyscraper and chances are you may see a window washer making it shine. Cleaning at height isn't an easy job, and workers deserve to feel secure, protected and mobile. Their safety is key to standards; their confidence is vital to productivity.

That's where Latchways fall protection comes into view. We offer the complete window maintenance solution just right for you.





## Latchways Pushlock™ Fall Protection Starts on the Inside

When access from inside a building is needed to carry out external work such as window washing, Latchways PushLock delivers a stable, secure solution. With a range of sockets for fixing to brickwork, concrete and steelwork, it can be secured in walls, floors or ceilings. PushLock provides an internal fixed anchor to which workers can attach a lanyard and safety harness—allowing them to confidently take on the job.

- Eyebolt requires two-handed operation, making accidental removal impossible
- A variety of colors and finishes available including stainless steel, brass and a range of RAL colors
- Socket and eyebolt both statically tested to 2248 lbs (10 kN)
- Meets all relevant national and international standards



**1** Install brass finished PushLock socket into a cavity wall.



**2** Depress the safety catch then locate eyebolt into center of socket. Push the eyebolt with palm of hand until locking mechanism clicks.



**3** Check installation by tugging the eyebolt. In the secure position, the word "LOCKED" is fully visible on the trigger. A safety lanyard attached to a full-body harness can now be connected to the eyebolt—and the user can begin working.



**4** When work is done, remove the lanyard from the eyebolt. With two hands, depress safety catch then trigger to remove the eyebolt from the socket.

## Latchways VersiRail® Guardrail Systems

*An easier way  
to guard against  
fall hazards.*



Looks can be deceiving. Even in the simplest environments, at-height workers are still subject to falls—after all, just because the risk is minimal doesn't mean the risk is eliminated.

This is where MSA's passive fall protection systems come in.

It's called "passive" protection, because once properly installed, it doesn't require any action to be taken by the worker. Guardrails and netting are perfect examples of just such protection—helping to minimize risk by providing a barrier to the hazard while protecting more than one worker at a time.

Other scenarios where passive fall protection comes into play include areas where workers have frequent and regular access to locations, environments where tasks may take longer, and situations where workers aren't required to participate in personal protection equipment training.

No matter the passive scenario, it all adds up to one thing: the active need to protect every individual from fall hazards.







### On Guard for Fall Hazards

For flat surfaces up to a 10° slope, the MSA range of Latchways VersiRail guardrail systems offer collective protection designed to safeguard against falls. It's available in two different forms: as a freestanding system that requires no penetration, or as a fixed system that can be permanently attached to parapet walls or roof decks.

Made of durable aluminum and corrosion-resistant construction, these lightweight, fully weatherproof systems are quick and easy to install—not to mention versatile enough to be designed for any roof with up to 10 degrees pitch. They're also built with your aesthetic eye in mind. VersiRail systems are available in straight, curved or inclined styles, and they can be delivered with a polished finish or powder coated in a large array of colors.



# Latchways VersiRail® Guardrail Systems

## Straight Upright

### Classic design for a perfect fit

With its simple design built for seamless integration into your building's clean lines and contours, the straight upright system is well suited for protecting access points and demarcating walkways.

### Straight upright system with:

- 1 Slab mounting plate
- 2 Wall mounting plate
- 3 Z-type mounting plate
- 4 Parapet mounting plate

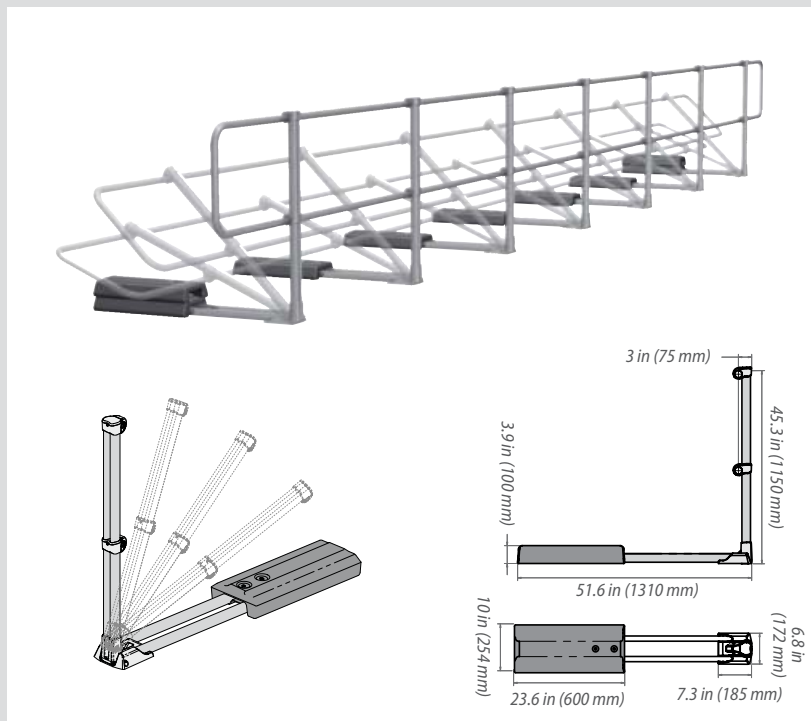
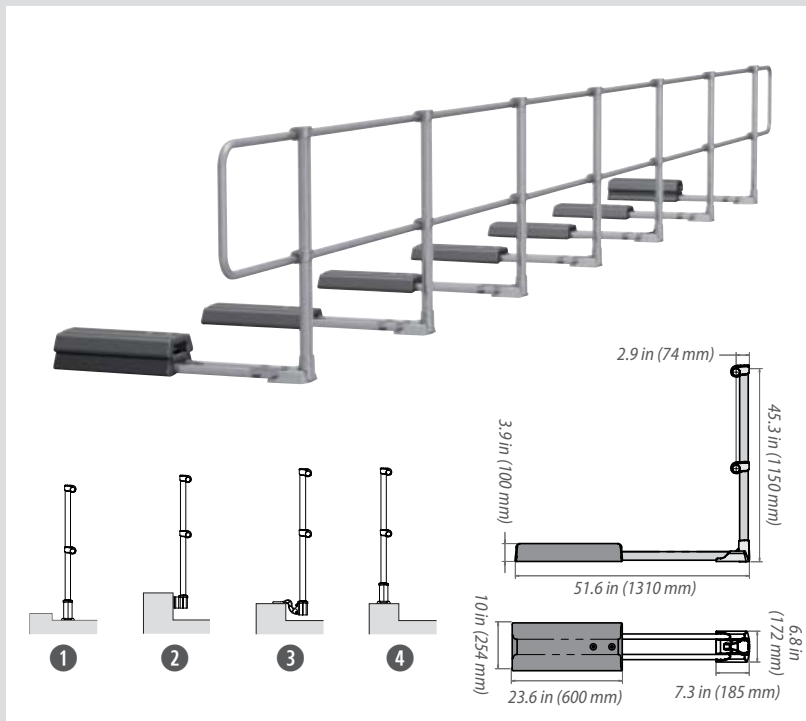

## Freestanding Folding

### Safety meets architectural aesthetics

When collective protection is not needed, VersiRail's folding uprights can lie flat, concealing the system from ground-level views. Available in straight, curved or inclined styles.

## Curved Upright

### Greater safety around the bend

With a sleek and handsome arc, the curved upright system adds to the design of your building while providing a greater level of safety by keeping workers farther from the roof edge.

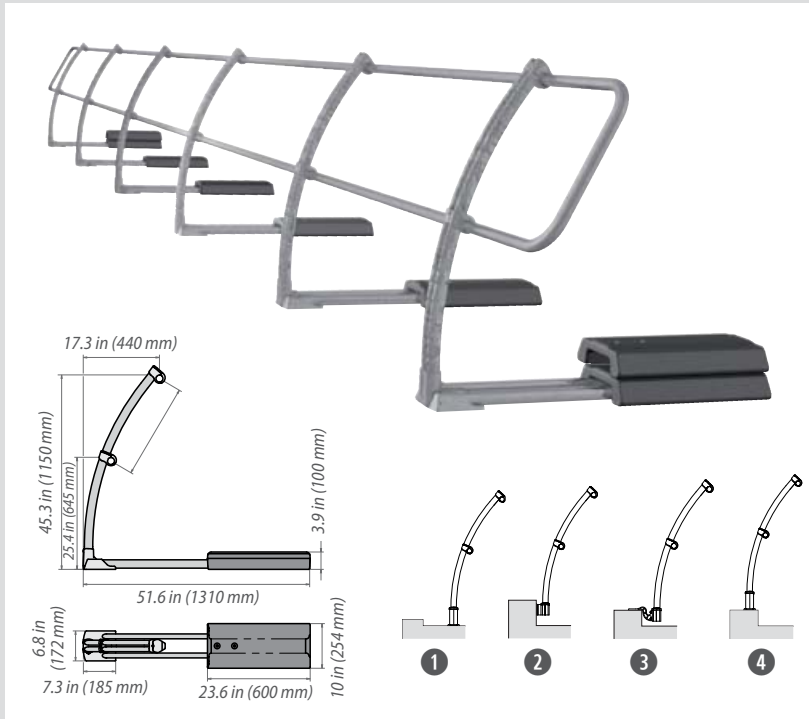

### Curved upright system with:

- 1 Slab mounting plate
- 2 Wall mounting plate
- 3 Z-type mounting plate
- 4 Parapet mounting plate

## Inclined Upright

### Artful integration upon sight

With its 20° incline, this aesthetically designed VersiRail variation better integrates into the building to be less visible from ground level.

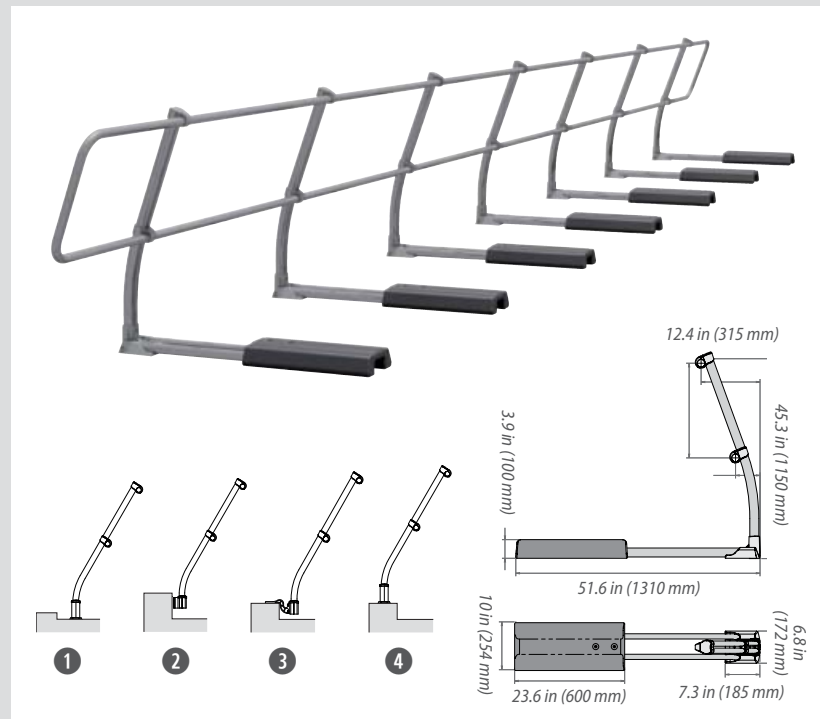

### Inclined upright system with:

- 1 Slab mounting plate
- 2 Wall mounting plate
- 3 Z-type mounting plate
- 4 Parapet mounting plate

## Latchways VersiRail Guardrail Systems

### Bringing flexibility and customization together

With so many modular easy-fix components to choose from, VersiRail can create a wide range of configurations just right for you.



#### Corner sections

When a change in system direction is required, standard 90° corners are available, while corner sections between 45° and 175° can be made to order.



#### Access gate

In areas where a VersiRail system prevents worker access to fall hazards, yet maintenance access in these same areas may still be needed, the access gate can be essential by providing trained personnel-controlled entry. Suitable for rooflights or trap doors.



#### Connecting elements

T-Junctions, 45–45 corner sections and junction parts are available to accommodate all system layouts.



#### Toeboard

On rooftops or surfaces without a parapet at the fall edge, a toeboard can be affixed to the base of the VersiRail guardrail.



#### Closure bends

In instances where a VersiRail system needs to terminate and can't be attached directly to a structural element, closure bends can be incorporated into the length of a system to designate a safe entry and exit.

### Fixing options

MSA offers brackets for fixing on or to parapet walls, using either M10 or M12 bolts.



Slab mounting plate



Wall mounting plate



Z-type mounting plate



Parapet mounting plate

Please note that these fixings should be chemically sealed where possible and that it's critical to check the suitability of the material on which the fixed VersiRail system is to be installed.



## Latchways WalkSafe® Walkway Systems

*Keep a step ahead  
with WalkSafe*

Often it's necessary (and good business) to install a fall protection system that offers maximum safety even in the face of minimal danger. WalkSafe walkway systems attach to rooftops to create a level, anti-slip surface that keeps workers protected against potential fall hazards. In addition to offering ease of access up sloped or pitched roofs, WalkSafe's leveled walkways help provide workers a defined route that guides them away from hazards.

Manufactured from recycled PVCu, WalkSafe systems are designed to distribute the load evenly on the roof, reducing wear and tear on the roofing system itself. This is particularly useful in instances where regular access is required, for example in plant inspection, rooftop cleaning or air quality monitoring.

Versatile in its applications for easy customization, WalkSafe systems work on all major roof systems—from standing-seam to corrugated metal to single-ply membrane.

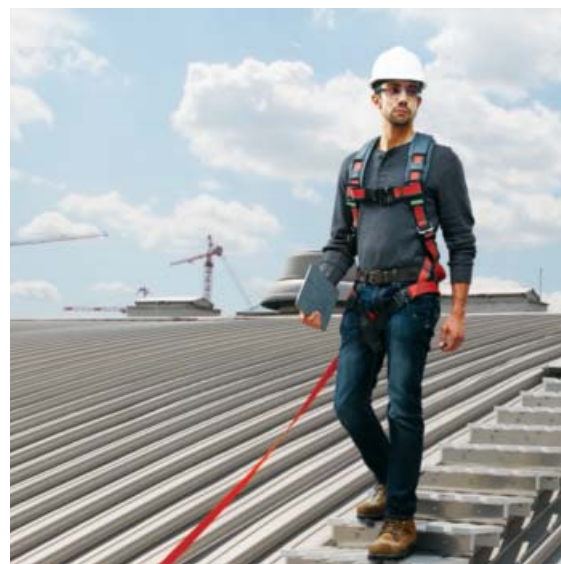

### Key Advantages

- Lifespan in excess of 25 years
- Manufactured from recycled PVCu and can therefore be recycled again
- Lightweight construction
- Designed for use on all major roofing systems
- Manufactured in the UK
- Class 1Y against B476 fire resistance test
- Tested to ACR[M]001:2014 for fragility and achieved an "A" classification
- Tropical alternative available for high-heat and high-UV conditions
- Coefficient of friction:
  - Dry 0.57
  - Wet 0.51



## WalkSafe Walkway Layout

What makes a Latchways WalkSafe system the ideal choice for you is its stunning flexibility and customization—you can truly build it as you see fit. Whatever your structure, needs and preferences, MSA is the optimal fall protection partner, allowing you to personalize your safety system with different fixing methods, configurations and more.

The orientation of the WalkSafe planks within a system is described as either shortways (running across the roofing profile) or longways (running with the roofing profile).

The system can be configured in four ways to cover corners and change of direction: as a T-section, longways to shortways or vice versa; or as a corner section either to shortways “end” or longways “side.”

Simply put, while the product is all Latchways, the system configuration is all you. Contact a Latchways installation representative to find out more.

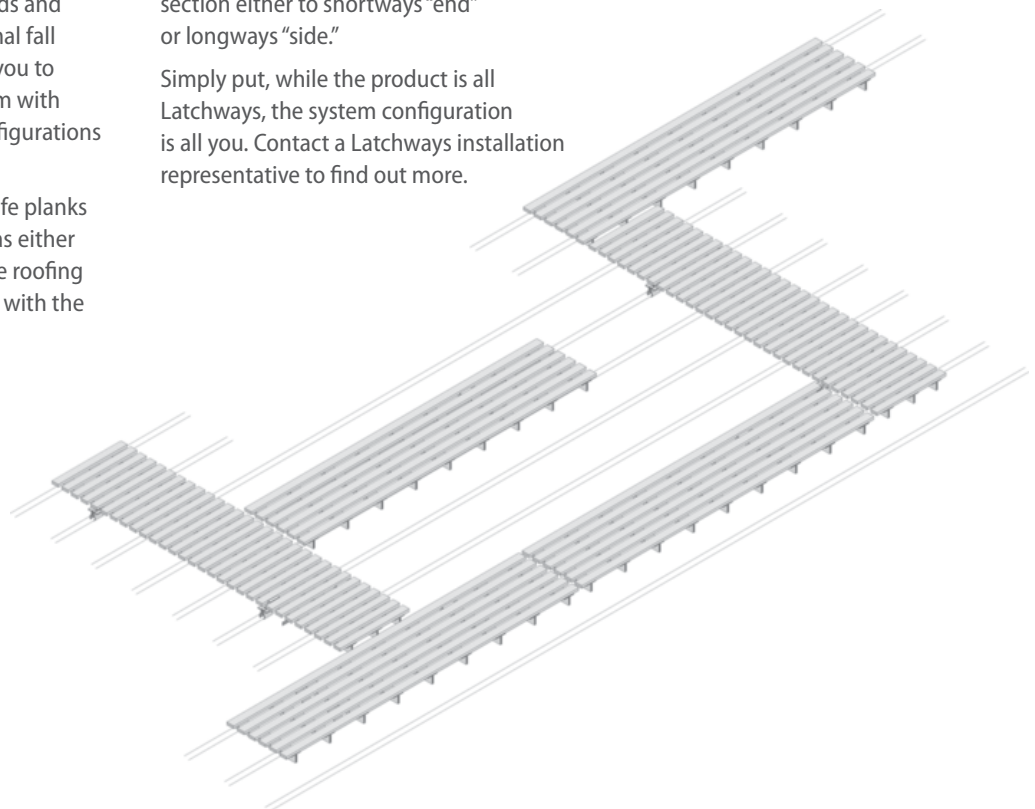

# Latchways WalkSafe Walkway Systems

## WalkSafe Walkway Systems Fixing Options

The simplicity of a WalkSafe system stems from its ability to combine simplicity of design with mastery of expertise. Our 9 ft (2.7 m) long by 10" (254 mm) wide panels require only top-fixing to the roof system. In most cases, the fixings are non-penetrative.

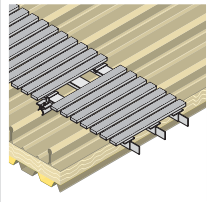
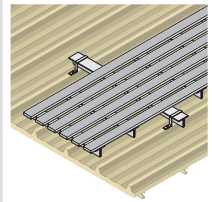
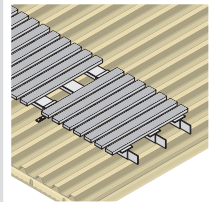
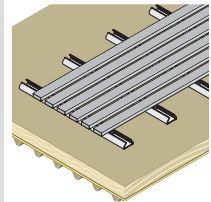
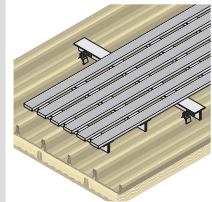
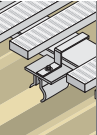
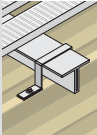
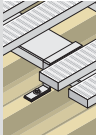
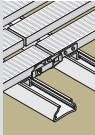
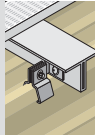
Shortways system on standing-seam roofing	Longways system on corrugated metal roofing	Shortways system on built-up-on-site roofing	Longways system on single-ply membrane roofing	Longways system on secret-fix roofing
				
 Fixing method: Standing-seam clamps	 Fixing method: Retaining brackets	 Fixing method: Retaining brackets	 Fixing method: Self-weighted panels are joined with toggle clamp	 Fixing method: Secret-fix clamps

## WalkSafe Pitched-Roof Systems

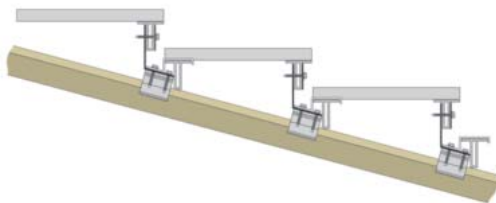

### Step Systems

WalkSafe's design flexibility allows it to be used as leveled walkways, providing safe access to all parts of the roof on slopes up to 15°, or as steps on steeper gradients.

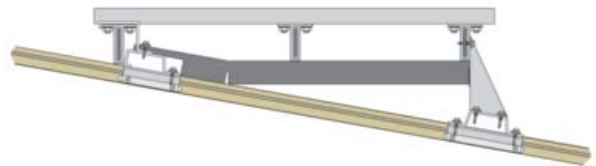

### Traversing Systems

Where a level walkway is required, it is key that the correct roof angle is identified because the leveling brackets are purpose-built for each job. Traversing WalkSafe systems utilize different components to the stepped systems, therefore careful consideration must be given when detailing areas requiring access.







## WalkSafe Fall-Proof Covers

If installing fall protection systems isn't possible, then installing passive protection such as WalkSafe Fall-Proof Covers or Skylight Covers is the next best solution. Whether on flat or pitched fragile roofs, WalkSafe covers can be used adjacent to WalkSafe Walkway systems and can work apart from—or, ideally, jointly with—other Latchways fall protection solutions. Better still, these easily installed covers eliminate the possibility of user error, since they don't require user training.

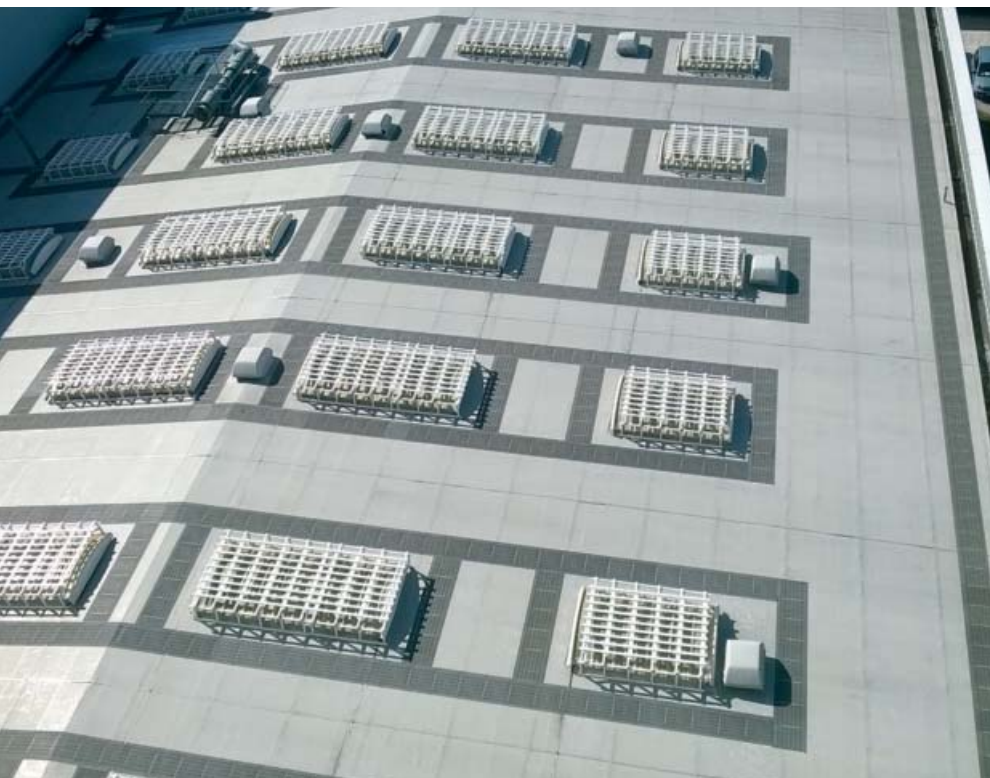

## WalkSafe Skylight Covers

Wherever in-plane or raised skylights are installed, WalkSafe Skylight Covers work to keep employees from falling through them. As skylights often vary in shape and size, WalkSafe solutions can be customized to fit your particular needs.

Contact your local MSA representative to help you and your local Latchways Registered Installer design an appropriate system just right for you.

## Latchways Horizontal Lifelines (HLL)

*Unique safety solutions  
for those working  
on the edge.*

Latchways horizontal lifelines are known worldwide for their versatility and ease of use, making them the ideal choice for protecting workers as they go about day-to-day activities like maintenance, cleaning, inspection and more.

Easily customized for virtually any structure or unique requirement, MSA precisely engineered horizontal systems are built to work in all areas of industry, construction and maintenance. Installations include retail outlets, stadiums, transmission towers and industrial complexes—not to mention famous sites like New York's Grand Central Station, the Hong Kong Airport, and the Eden Project in Cornwall, home to the world's largest indoor rainforest.

Committed to bringing you the best in quality, versatility and satisfaction, MSA continues to work closely with major roofing manufacturers to produce a full range of fall protection systems for all designs and types of roofs.





### Constant Force® Post Technology

In typical leadership fashion, MSA takes the science of Latchways Constant Force and applies it to the fall protection industry—providing an easy-to-install, reliable and cost-effective solution to rooftop safety.

### Constant Force Explained

The principles of fall arrest are based on effective load control, meaning that a system must be able to withstand the force of a person's fall while absorbing the energy it generates. In the past, this was achieved by attaching the system to the structure of the building with the anchor point absorbing the load. This inherently caused difficulties for designers and installers, since the system location was determined by the structural elements of the building. System installation, meanwhile, was time consuming because anchors had to be fixed above and below, often creating issues regarding warranties, leakage and cold bridging.

### The MSA Solution

Latchways Constant Force post (CFP) does not need to be fixed to the building structure but instead top-fixes to the roof, therefore simplifying installation, saving time and protecting structures from compromise. With Constant Force technology as its governing principle, the load generated in the event of a fall is absorbed through the Latchways system, minimizing loads placed on the roof structure.

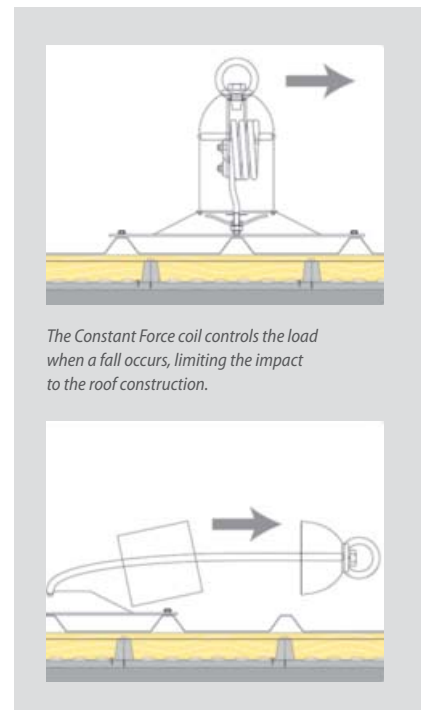

*The Constant Force coil controls the load when a fall occurs, limiting the impact to the roof construction.*

# Latchways Horizontal Lifelines (HLL)

## Constant Force® Post Components

Recognizing the importance of installing a fully compliant solution to all major roof constructions, manufacturers across the globe were consulted to create a brilliantly compatible anchor: the Latchways Constant Force post. With just a handful of components, the Constant Force technology can be designed to fit nearly any roof configuration.



### Latchways Transfastener™

The user, wearing a full-body harness and energy-absorbing lanyard, is continuously attached to the system with a Transfastener, MSA's innovative device that can rotate its way through the intermediate cable supports. For systems with no entry terminal, a Removable Transfastener can be used.

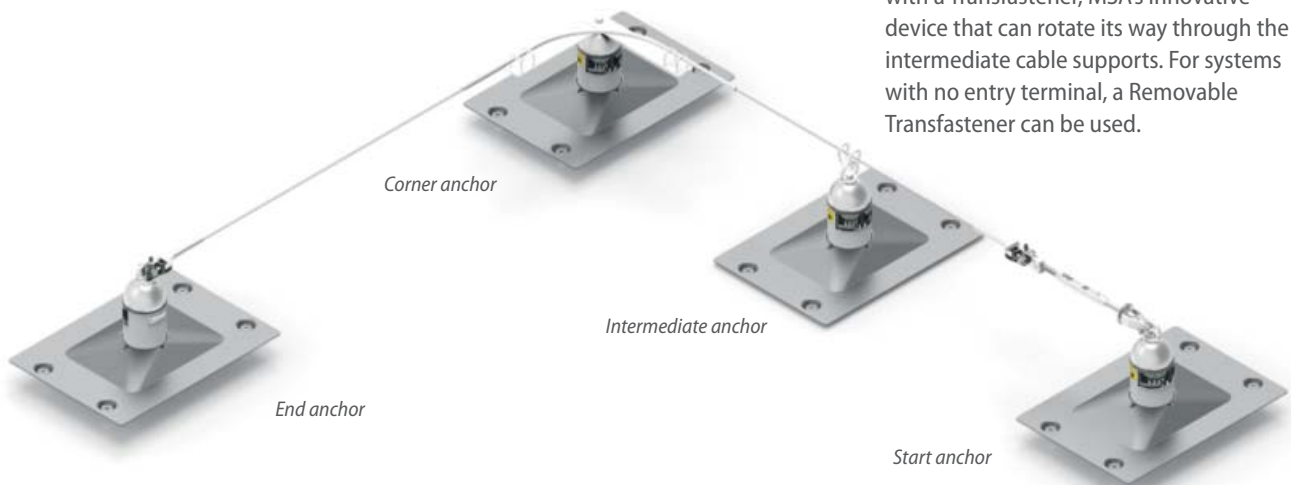

## System Components



### Turnbuckle Assembly

The turnbuckle assembly provides a cable termination and method of tensioning the system. The integral indicator disc spins when the correct system tension is reached.



### Swage & Clevis

The swage and clevis unit provides the method of terminating the cable at the opposite end of the system to the turnbuckle assembly.



### 90° Corner Bracket

This one-piece corner bracket, attached to an intermediate anchor, provides an angle change of 90° within the system.



### Variable Bracket

This bracket attaches to an intermediate anchor and provides an angle change of between 0° and 80° on either horizontal or vertical planes.



### D-Ring & Hanger

The D-ring and hanger form an intermediate cable support. The cable is threaded through the hanger, allowing the Transfastener to travel the length of the system without disconnecting.

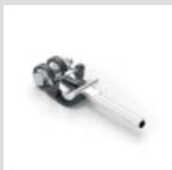

### Entry Terminal

Where a Transfastener is used on a system, the entry terminal is used to enable entry and connection.

## Roof-Type Fixing Options

Latchways Constant Force systems bring complete fall protection solutions to both fall restraint and fall arrest. The simplicity of our fixings allows for quick and easy installation, providing safe solutions to workers at height.

Latchways systems work with all major roof manufacturers. To understand how Latchways Constant Force posts fix to manufacturers' individual roofing systems, please contact [spec@latchways.com](mailto:spec@latchways.com).

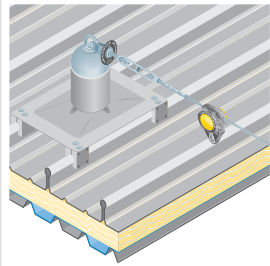
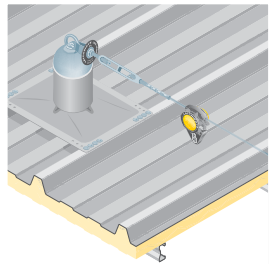
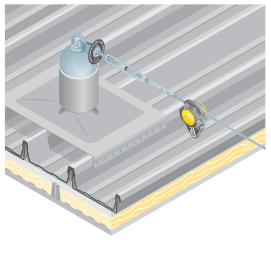
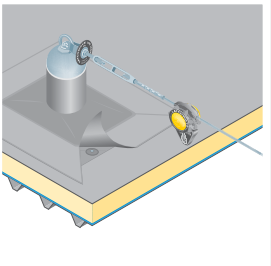
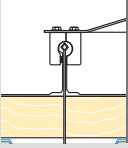
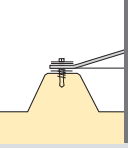
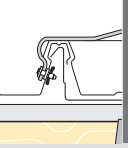
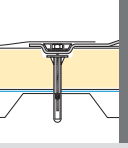
Constant Force post on standing-seam roofing	Constant Force post on corrugated metal decking	Constant Force post on secret-fix roofing	Constant Force post on flat roofing
			
 Fixing Method: 4 split clamps	 Fixing Method: 16 stitching screws/bulb tite rivets	 Fixing Method: 20 bulb tite water seal rivets	 Fixing Method: 4 toggle bolts



## Freestanding Constant Force® Post

Typically, a cable-based system is installed top-fixed to the roof structure. However, this isn't always practical or desired—for example, when a permanent roof edge or gutter maintenance system is in place but a “one-off” repair is required in the center or another location accessible from this system. Another example is when the facility is being leased and alterations to the roof are not allowed.

For these situations and more, you need the Latchways freestanding Constant Force post (CFP). To be used on a single-ply roof only, this expertly engineered self-weighted anchor incorporates CFP technology but does not require fixing through the roof sheet. When required, a number of CFPs can be combined to create a full system.

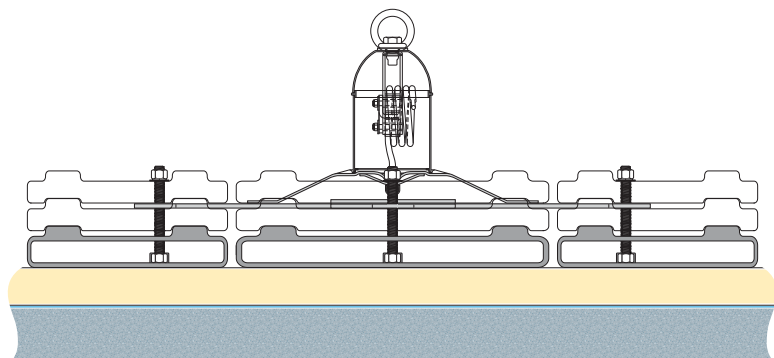

## Latchways Horizontal Lifelines (HLL)

*Confidence,  
with a little help  
from up above.*



With Latchways overhead systems, all you have to do is look up and you'll find a greater sense of security and confidence.

Combining MSA's unique knowledge of fall protection with innovative Constant Force technology, our overhead systems deliver maximum accessibility and hands-free mobility—not to mention ease of use and simple installation.

The Latchways range of overhead systems house Constant Force technology in an in-line energy absorber, so if a worker connected to the system should fall, the Constant Force energy absorber controls the load back to the structure. Simply put, it's a smartly designed system precisely engineered to react lightning quick.

Ideal for industrial environments and in applications such as warehouses, loading bays and airplane hangars, Latchways overhead system is heads above when it comes to fall protection safety.



## Overhead Systems—Single- and Multi-Span Systems Components

Did you know that, for systems up to 200 ft (61 m), intermediate brackets are not necessary? Latchways overhead systems remove the need for structural elements and intermediate bracket fittings to be installed. **Latchways is the only product to achieve this.**

### Single-Span System Components—distances up to 200 ft (61 m)



#### Constant Force Energy Absorber

Located at one end of the system, the energy absorber ensures that, in the event of a fall, the maximum load transferred to the structure does not exceed 4047 lbs (18 kN).



#### Overhead System Mobile Anchorage

Allows an SRL to be connected to the overhead system.



#### Line Tensioning Device

Allows the system to be correctly tensioned for use. The indicator disc will spin freely when the correct tension is reached at 1124 lbs (5 kN).

### Multi-Span System Components—all distances and those greater than 200 ft (61 m)



#### Mobile Anchorage

Allows an SRL to be connected to the overhead system. Anchorage can travel over intermediate brackets without disconnection.

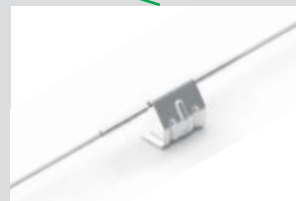

#### Intermediate Brackets

Support the cable on multi-span systems and also accommodate change in direction.

## Latchways Vertical Lifelines (VLL)

*Engineered solutions  
that deliver freedom  
and security.*

Anywhere in the world, wherever there's a call for telecoms, masts, rooftops or any at-height work space—you are likely to find a Latchways vertical cable-based fall protection system. All you have to do is scan the horizon.

Featuring our brilliantly engineered TowerLatch™ and LadderLatch™ systems, the Latchways system options offer outstanding personal safety for those working at height, particularly in the telecom and wind energy industries. Both TowerLatch and LadderLatch emphasize inherent flexibility, meaning they can be configured for a wide variety of applications, including ladders, towers, masts, monopoles and other structures specific to these industries.

### Dedicated to Safety

- **Reliable security:** Our VLLs incorporate a fluorescent red indicator that appears in the event of a fall
- **Flexible freedom:** Each systems' universal attachment device rotates freely through intermediate cable guides for continuous hands-free protection
- **Load control:** In the event of a fall, the load applied to the worker is limited to a maximum of 1349 lbs (6 kN) by either a Constant Force® absorber at the top of the system or a webbing energy absorber on the device
- **Inspection:** TowerLatch and LadderLatch systems are regarded as part of the tower structure, and inspected accordingly
- **Trusted quality:** Both systems meet or exceed all relevant international standards
- **Extra security:** A webbing stop can be incorporated into the systems' attachment device to facilitate rescue as needed



### Fixed Ladder Systems

With its simple design concept built for optimal flexibility and superior protection, MSA TowerLatch and LadderLatch systems can be installed to follow the contours of any structure, maximizing the system's safety value in a working environment.





## Fall Protection Worldwide

Whether working a telecom tower, wind turbine or offshore rig, our global network of registered partner companies ensures that product quality is matched by equally high standards of installation and maintenance. And, with offices and our Registered Installers located globally, MSA has the capacity to specify and install vertical systems to all industries—no matter the location. Simply put: When it comes to global fall protection, MSA speaks your language.

MSA is proud to say that the following companies utilize Latchways vertical fall protection systems to keep workers safe and make a difference:

- Arqiva
- SWBremen
- Vodafone
- Scottish and Southern
- AusNet Services
- Ericsson
- Transpower
- TenneT



## Networks and Telecoms

MSA's mission is to make sure every customer gets the solution they need. Whether the systems you require are for greenfield sites or rooftops sites, new build or retrofit, network roll-out programs or upgrading of antennas, MSA offers tailor-made service with maximum support.



## Transmission Towers

Flexible enough to accommodate every safety need for working at height, Latchways vertical systems are ideal for personnel accessing high-voltage transmission towers or transformers in substations.



## Wind Turbines

When ascending a ladder within a new build or retrofit turbine, rely on Latchways TowerLatch to deliver the ideal hands-free solution, securing the climber to the cable via the chest D-ring on their full-body harness.

# Latchways Vertical Lifelines (VLL)

The LadderLatch™ and TowerLatch™ systems are two great examples of how MSA modernizes fall protection for the tough, complex needs of today. The Latchways range began more than 40 years ago, revolutionizing the industry with patented Constant Force technology. Since then, we've developed many more breakthrough technologies and innovative products that continue to impact the fall protection industry in profound, meaningful ways.

### Engineering excellence

All MSA systems are manufactured to the highest international standards, using only the best materials. Critical components are individually numbered and batch-conformance and dye-penetrant tested—a quality standard unsurpassed in the industry. In addition to rigorous in-house testing, all MSA products undergo external verification to ensure they meet or exceed relevant industry standards.

The TowerLatch system has also been subjected to accelerated aging, wind tunnel trials and cyclic testing—all of which have confirmed the inherent quality and durability of the system.

MSA products are specifically developed to take into account the latest structural innovations, while the company's commitment to excellence means that its systems have a proven track record of safety and reliability—even in the most extreme environments.



### Ease of installation and use

As experts in the field, we know how valuable your time is and how important convenience is to you. That's why our vertical systems are designed to allow for the following:

- Incorporation at the design stage for new towers or retrofitting to existing structures
- Installation that follows the contours of any structure, including horizontal and inclined sections
- A comprehensive range of components that enables quick and easy installation on any type of overhead line tower, vertical structure or ladder
- Utilization by up to six users
- Units that can be attached or detached at any point in the system
- Installation in virtually any environment



# Fixed Ladder Systems

For use on stadiums, oil rigs, land-based wind towers and other elevated work environments, Latchways fixed ladder systems are always ready for climbing. Featuring our innovative LadderLatch™ unit, with its unique starwheel component that provides continuous security with hands-free climbing, our fixed ladder systems are designed to maximize confidence and productivity. And, because they are flexible enough to follow the contours of virtually any structure, these fixed ladder systems maximize the safety value in a working environment, too.



Fixed ladder systems use the LadderLatch attachment device. See page 61 for more information.

## Putting a typical system together

A typical vertical system usually consists of a top anchor, a bottom anchor and a Constant Force energy absorber in between.

### Top anchor

The top anchor is a bracket with a built-in safety factor greater than 2 times the potential load generated when a fall occurs.

### Constant Force energy absorber

The Constant Force energy absorber ensures that the load applied back to the structure and the climber, in the event of a fall, is limited to a maximum of 6 kN.

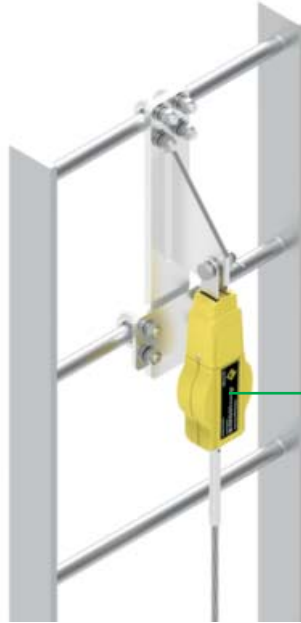

### Intermediate cable guides

These brackets support the cable, ensuring that a correct stand-off distance from the structure is maintained. The spacing of the intermediates is dependent on the height and location of the structure. An extensive range is available to cater to all types of structure.



### Bottom anchor

The bottom anchor is a bracket that provides a swage-free system termination and an integral tensioning device. At the correct cable pre-tension, the unit's indicator disc will spin freely. Captive security bolts prevent unauthorized system adjustment.



# Latchways MonoStep System for Telecom Masts

MSA always searches for ways to satisfy our customers' fall protection needs. One great example of this is our MonoStep removable step system, developed in response to telecom companies' need for unobtrusive, tamper-proof climbing systems for their monopole structures. The Latchways MonoStep is an ideal system for use on the first 9 to 13 ft (3 to 4 m) of a pole and designed to work in conjunction with the Latchways TowerLatch™ device.

## Top anchor

This bracket has a built-in safety factor of greater than 2 times the potential load generated when a fall occurs. The system energy absorber is attached at this point.

## Constant Force energy absorber

The Constant Force energy absorber ensures that, in the event of a fall, the load applied back to the structure and the climber is limited to a maximum of 1349 lbs (6 kN). A three- or six-person version is available, with both units having a red fluorescent indicator showing if a fall has occurred.

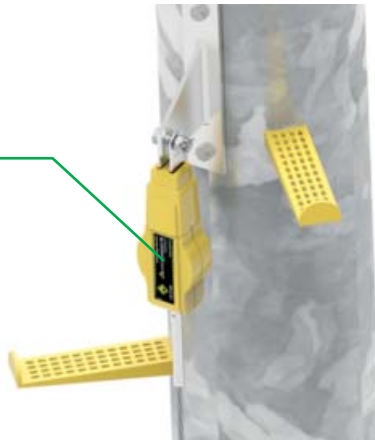

## MonoStep

You can easily install and remove the smartly designed MonoStep: simply click the step over studs mounted on the monopole.



## Bottom anchors

This bottom bracket provides a swage-free system termination and an integral tensioning device. At the correct cable pre-tension, the unit's indicator disc will spin freely. Unauthorized system adjustment is prevented through the use of captive security bolts.



The Monostep system uses the TowerLatch™ attachment device. See page 61 for more information.



## Customer Focus

Arqiva | Europe



*"Latchways has more than taken care of our need to keep our workers safe at height. The 'more' comes in the extreme ease of use and rapid installation of their vertical systems. Our maintenance tasks have to be completed quickly. The Latchways kit enables us to get the job done fast; and that makes a noteworthy contribution to keeping our operational expenditure within fixed guidelines."*

— **Dan Hobbs**  
Customer Delivery Manager, Arqiva

Read the full case study at [latchways.com/case-studies](https://latchways.com/case-studies).

# TowerLatch™ Engineered Cable Lifelines

There are two types of systems for overhead line towers: StepBolt and L-Bolt.

## StepBolt

Latchways StepBolt is a vertical fall protection system for retrofitting to overhead line tower climbing legs. Fixed to the structure by the step bolts, the system has no in-line energy absorber. The TowerLatch SP attachment device incorporates a built-in energy-absorbing pack to reduce the end load in the event of a fall. The system is designed for use by up to four workers at the same time.

## L-Bolt

Like the StepBolt, Latchways L-Bolt system is also for retrofitting to overhead line tower climbing legs—though it is fixed to the tower by L-bolts, which are available in a range of sizes to suit each structure. The TowerLatch attachment device incorporates a webbing strop to facilitate rescue.



### Top anchor

This bracket has a built-in safety factor of greater than 2 times the potential load generated when a fall occurs. The Constant Force energy absorber can be attached at this point.

### Constant Force energy absorber (L-Bolt system only)

The Constant Force energy absorber ensures that, in the event of a fall, the load applied back to the structure and the climber is limited to a maximum of 1349 lbs (6 kN). A three- or six-person version is available, with both units having a red fluorescent indicator showing if a fall has occurred.



### Intermediate cable guides

These brackets support the cable, ensuring that a correct stand-off distance from the structure is maintained and also controls the cable against the effects of wind. The spacing of the intermediates depends on the height and location of the structure. An extensive range is available to cater to all types of structures.



### Bottom anchor

This bottom bracket provides a swage-free system termination and an integral tensioning device. At the correct cable pre-tension, the unit's indicator disc will spin freely. Captive security bolts prevent unauthorized system adjustment.





## Customer Focus

TenneT | Europe



TowerLatch systems for overhead towers use the TowerLatch or TowerLatch SP attachment devices. See page 61 for more information.

*"We chose Latchways after looking at all the systems on the market. Latchways was the best technical solution and was competitively priced. I have found their people to be professional and efficient, and our workers like to use the system."*

— **F.W. Kwakman**  
**Project Leader Maintenance, TenneT**

Read the full case study at [latchways.com/case-studies](https://latchways.com/case-studies).

## Latchways Inclined Systems

*Systems inclined  
to succeed.*

While working at height is tough, working at height on an incline can present uniquely different challenges. MSA has developed a comprehensive range of Latchways system components that can be configured to provide a tailored cable lifeline suited to structures that slope.

Our two main components, the BridgeLatch™ and ClimbLatch™ devices, are built to bring optimal security, flexibility and mobility to the at-height, on-incline workplace.

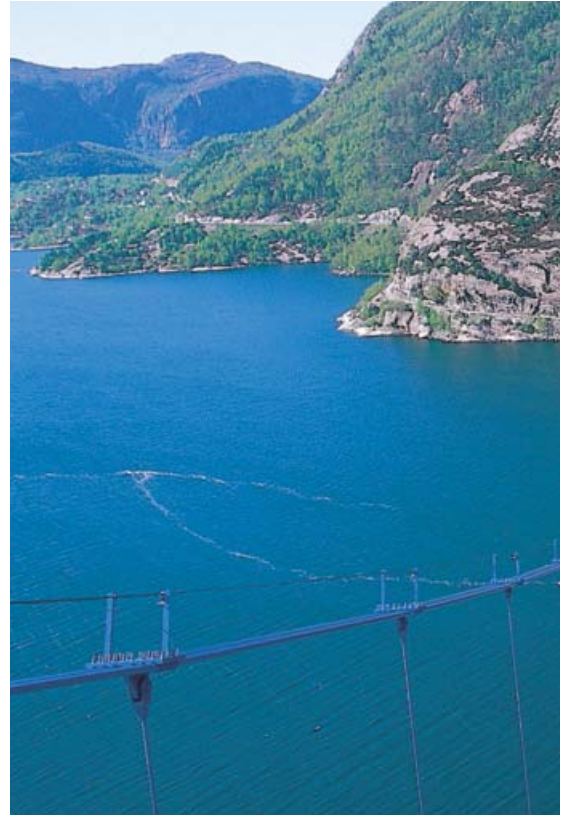

### BridgeLatch



BridgeLatch Device

For inclined lifelines running between 0° and 70°, the Latchways BridgeLatch device secures the user to the cable via a fixed-length lanyard connecting to the D-ring attachment point of a full-body harness.

Featuring a starwheel mechanism that rotates freely over intermediate cable supports and brackets, this smartly engineered device eliminates the disconnection requirement that can lead to potential accidents or loss in productivity.

The result is confident, hands-free operation with optimal freedom of movement, because workers can now move up or down the cable system's incline—without the need to detach.

Better still, in the event of a fall, the BridgeLatch device is designed to clamp fast onto the cable, preventing the user from falling or sliding down the incline on which they're working.

Depending on the incline of the system, MSA offers two different types of devices: one that covers inclines up to a 40° pitch, another that should be used on a pitch of up to 70°.





### Bridges

BridgeLatch is an ideal choice when the cable system you're attaching to is located at waist height, such as when walking on bridge suspension cables. The Latchways BridgeLatch device has been utilized across the world, including on the Lyiesford Bridges in Norway.

### Stadiums

BridgeLatch is the chosen attachment device on more unusual constructions, including highly popular visitor attractions such as "Up at the O2"—where a BridgeLatch device and cable system assists thousands of tourists as they climb and descend the steep profile of the O2 Arena in London.

## Uniquely MSA Latchways

What might a Latchways BridgeLatch system look like?



#### Entry and exit terminals

*BridgeLatch can be connected and disconnected only at designated entry and exit terminals. This built-in safety feature is designed to prevent the user from improperly using or accidentally disconnecting from the device.*



#### Cable

*Latchways uses a 3/16" (8 mm) 1 x 19" 316-grade stainless-steel cable that has a unique identification system. The cable is factory tested to check its physical properties and to ensure consistent performance.*



#### Intermediate cable guides

*These brackets support the cable, keeping the correct stand-off distance from the structure. The design of the bracket allows for easy retrofit, while the spacing of the brackets is dependent on the height and location of the structure.*



#### Mid-entry terminal

*With a mid-entry terminal, a user can enter or exit the system at any designated point rather than having to return to the terminals at the ends of the system.*

## Latchways Inclined Systems

*When inclined,  
go vertical.*

Designed to protect the user from a sliding fall on a sloped surface, the Climblatch™ device was created for use on an inclined system between 15° and 40°—though it can also be used on a system that moves from horizontal to vertical orientation.

Compatibility among components ensures your customized system—whether vertical, horizontal or inclined—delivers smooth, continuous transitions.



*Climblatch Device*

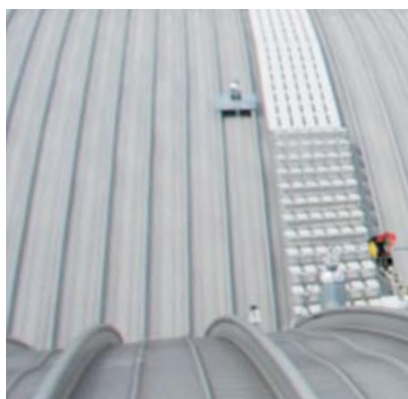

### Climblatch

Like the BridgeLatch device, Climblatch permits hands-free travel up sloped surfaces, freeing the worker to use both hands for work or climbing. Safety features include a required entry point on which to attach to the system. In the event of a fall, the Climblatch device locks onto the cable, not only arresting the fall but keeping the worker from sliding down the system.

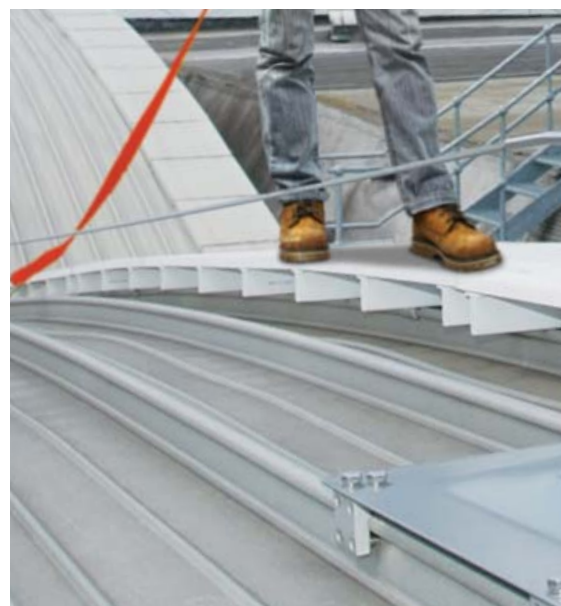



## Case Study

The O2 Arena | London, England

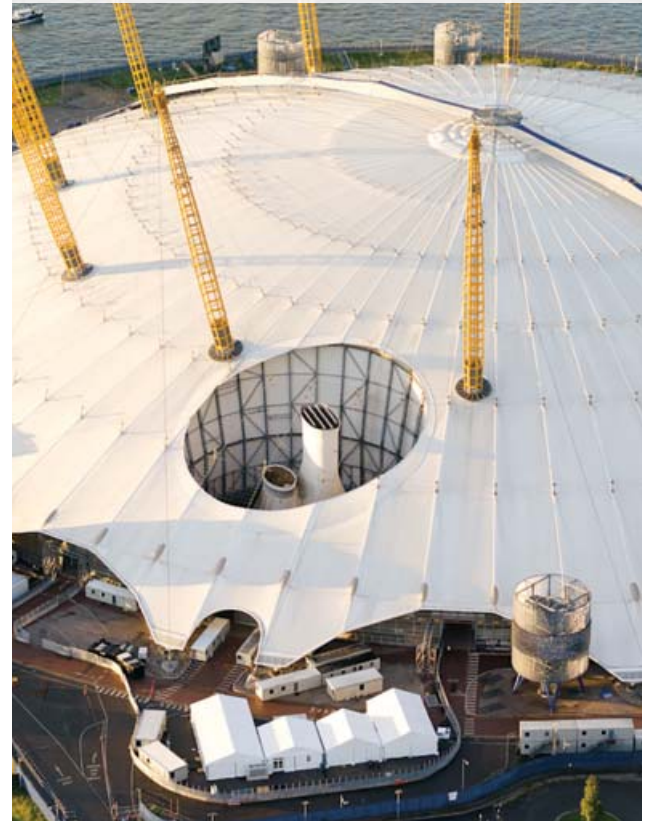

Making fearless explorers of us all.

*Why would any tourist willingly choose to climb the roof of The O2 Arena—a London icon that, at its highest peak, is 172 feet off the ground? Is it for the challenge? The adventure? The skyline with its 360 degrees of famous views?*

**We like to think it's because MSA emboldens tourists with a sense of safety and a feeling of trust.**

*To make this tourist destination attractive, The O2 called on MSA to team up with designers to create an artistically engaging, user-friendly fall protection system that would accommodate multiple users, regardless of their expertise.*

*MSA state-of-the-art Latchways horizontal cable system, in conjunction with the BridgeLatch device, was the perfect answer—here's why: Because the system requires user input, it satisfied The O2's request for tourists to be able to control their own climb. And, because the BridgeLatch is so simple and intuitive to use, tourists need only minimal training.*

## Attachment Devices

*Secure connection.  
Hands-free  
Operation.*

All Latchways attachment devices are designed to connect the user, wearing a full-body harness, to a Latchways cable system.

Common to all devices is the patented starwheel mechanism, which rotates freely over intermediate cable supports and around corner brackets without needing to disconnect the unit. This allows hands-free operation for the system users.



### Transfastener™ and Removable Transfastener

- Universal device for use on all Latchways horizontal systems, suitable for both fall restraint and arrest systems
- Incorporates unique starwheel, allowing the unit to pass over cable supports and corners without the need to detach
- Connects to user at dorsal point via an energy-absorbing lanyard
- While the Transfastener requires a specific entry point, the Removable Transfastener can attach or detach at any safe point



## LadderLatch™ and TowerLatch™

- Universal device for use on all Latchways vertical systems
- Incorporates unique starwheel, allowing the unit to pass over cable supports without need to detach
- Anti-inversion mechanism prevents device from connecting to the cable upside-down
- Connects to user at chest point
- Able to attach or detach at any safe point of the system
- In the event of a fall, the unit locks onto the cable and arrests the fall



**LadderLatch**



**TowerLatch** with integral webbing strap to provide fast post-fall rescue

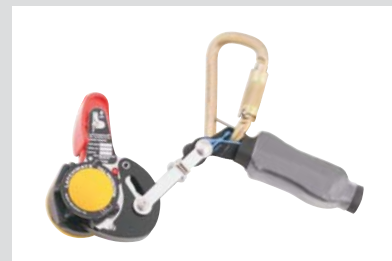

**TowerLatch SP** with an integral energy absorber ("shock pack") for use where a Constant Force absorber is not present in the vertical lifeline system



## BridgeLatch™

Latchways BridgeLatch device secures the user to the lifeline cable on inclines that run between 0° and 70°.

Featuring our groundbreaking starwheel mechanism that rotates freely over intermediate cable supports and brackets, BridgeLatch's intelligent engineering means you don't have to disconnect the unit and risk potential accidents or loss in productivity.

The result is remarkable freedom of movement and hands-free operation so users can do their best, most confident work.



## ClimbLatch™

The ClimbLatch device has many similar features of the LadderLatch and TowerLatch but is designed to be used on an inclined system—suitable for inclines between 0° and 40°.

## Latchways WinGrip® Vacuum Anchor

*The best anchor  
before take-off.*

**Latchways WinGrip is a vacuum anchor fall protection system used in the maintenance and manufacturing of aircraft.**

As flexible as it is safe, WinGrip can be fixed to wings, fuselage or stabilizers. The system is quick to install, easy to use and suitable for work inside the hangar, or outside, on the apron. Originally developed in collaboration with aircraft engineers seeking revolutionary new ways to protect workers at height, the first WinGrip vacuum anchor systems were delivered to British Airways in 1999. These first single-user systems gave the industry a time saving, cost-cutting lift by delivering fall protection in a radius around the anchor, in virtually any location on the aircraft—and they're still being used today. In fact, these days WinGrip is so ubiquitous, you'll find it in the aircraft maintenance manuals of both Boeing and Airbus.

Latchways WinGrip aerospace line consists of four different products—each with its own unique benefits that accommodate ever-evolving customer needs and ever-changing legislative requirements.

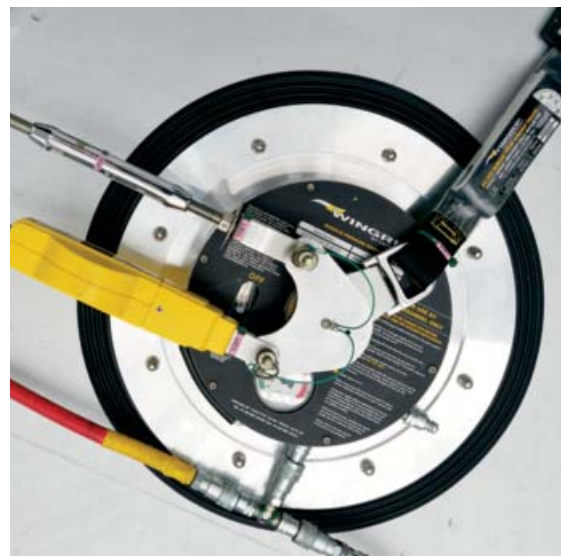



### WinGrip at a Glance

- Lightweight and portable anchors weigh less than 13 lbs (5.9 kg).
- Suitable for wet or dry surfaces, inside hangars, or on the apron
- Inherently safe, even with fuel tanks open—runs on compressed air or nitrogen; no electrical requirements
- Approved and used by all major aircraft manufacturers
- Easy to install and simple hands-free operation
- Independently tested to meet all relevant international standards
- Absence of metal-on-metal contact protects surfaces and eliminates risk of sparking
- Single- or multiple-user cable-based systems are available
- Suitable for heavy and light maintenance environments
- Should air supply fail, an alarm will sound and workers have at least 20 minutes to reach safety

# Latchways WinGrip Vacuum Anchor

### **WinGrip Single-User System**

The original WinGrip is our single-user system, providing a fall protection anchor point for wings, fuselage or stabilizers. Highly portable, this easily installed system is particularly suited to line maintenance and other temporary work. Here, the anchor is positioned and vacuum-locked in place, then used by a worker wearing a full-body harness with a safety lanyard and work positioning rope, connected to the vacuum anchor. The adjustable work positioning rope provides comfortable hands-free operation within a radius of 10 ft (3 m). Two vacuum anchors can be used to triangulate and fix the worker's position.



### **WinGrip Barrier System**

The WinGrip barrier system offers multi-personnel protection. The system provides a safe, enclosed working environment for several workers at a time. Here, workers do not need to use harnesses or lanyards, and they require only basic training to work within the system. Initially designed for Boeing maintenance programs, our barrier system consists of a series of upright stanchions and telescoping horizontal rails. The stanchion is connected at the base to a WinGrip vacuum anchor and is fully adjustable, ensuring a perfect installation on flat or curved surfaces. The horizontal rails are adjustable in length and angle, allowing any shape of the system to be installed in large areas.

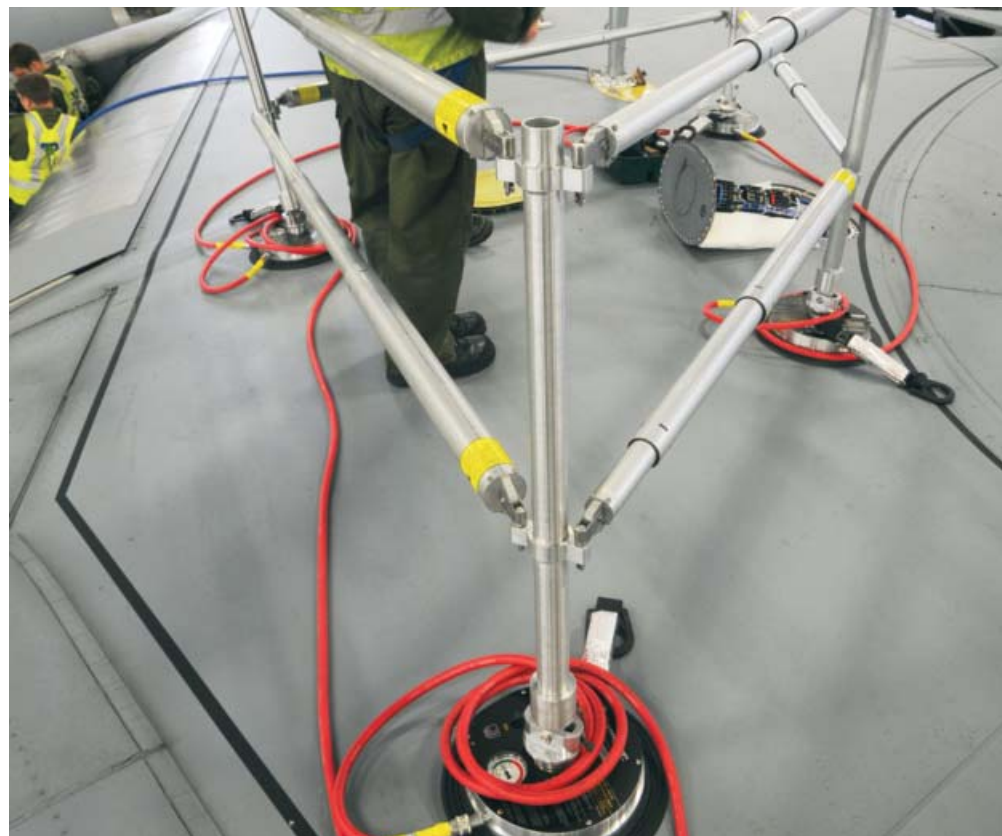





## WinGrip Lifeline System

The WinGrip lifeline system was introduced in 2005 as an ideal solution for use in construction, heavy maintenance and return operations, allowing for safe, hands-free access for multiple workers along the entire length of a wing or fuselage.

The system consists of two end-anchor vacuum anchors with cables spanning between them, and intermediate anchors as needed to suit any cable length. Each anchor is positioned and vacuum-locked in place, with stainless-steel safety cables connected and tensioned at one end. Workers connect to the cable using the unique Latchways shuttle. Up to four workers can use the system, wearing full-body harnesses and work positioning ropes. Built for greater flexibility and productivity, this system allows hands-free movement along the whole cable length, with shuttles gliding over intermediate anchors.

### System benefits

- Can be customized to fit any length of aircraft wing
- Ideal for heavy maintenance and longer access requirements
- Up to 4 users per system
- Fall arrest rated
- Safe method of installation and removal
- Provides full access to any wing without needing to disconnect
- Hands-free operation

## Latchways WinGrip AIO Vacuum Anchor

*Fall protection  
takes flight.*

Looking for ways to make flightline or hangar tasks more efficient, MSA's visionary team created the WinGrip AIO: a self-contained, compact, lightweight vacuum anchor. Powered by shop air supply or a refillable gas cylinder that provides at least six hours of stationary use, this marvel of fall protection technology is able to perform in extreme temperature—from arctic cold to desert heat. With little setup or removal time needed, the WinGrip AIO is ideal for use on “walking” areas of wings or structural sections of the fuselage.

Once the WinGrip AIO anchor has been vacuum-locked in place, the worker can attach to the system wearing a full-body harness and work positioning ropes with hands-free access to undertake all necessary maintenance. A single WinGrip AIO anchor provides a working area radius of nearly 10 ft (3 m), while an additional anchor can be attached to allow a larger work area. When using additional anchors, users can “step-stone” their way along the work area.

If for some reason the air or nitrogen supply used by the WinGrip AIO should fail, an audible alarm sounds, and the vacuum anchor will maintain a safe working vacuum for at least 20 minutes.





## Case Study

North State Aviation | North Carolina, USA

### Reputations soar within the aircraft MRO community

*North State Aviation in North Carolina is a maintenance, repair and overall (MRO) provider that's both fiercely proud and protective of its workforce. At the same time, North State is aware that, when it comes to aircraft maintenance, time is money. To quote Tom Chappell, North State's vice president of business development: "We know the airline business, and we know the value of having the aircraft out of the hangar and in the air."*

*North State needed a fall protection system that would not only give its workers a reliable solution when working on aircraft wings and fuselages, but would support their efficiency, flexibility and productivity.*

*WinGrip was the perfect solution for North State, because it allowed their aircraft workers to easily and quickly set up, use and dismantle our fall protection system. Not only is WinGrip an approved tool named by Airbus and Boeing aircraft maintenance manuals, it's also the one system whose warranties cover usage in wet conditions and with open fuel tanks.*

*With WinGrip, North State didn't just bring their workforce fall protection, it brought them all-around confidence.*

## MSA—The Safety Company

*Our business is safety. We've been the world's leading manufacturer of high-quality safety products since 1914. MSA products may be simple to use and maintain, but they're also highly-sophisticated devices and protective gear — the result of countless R&D hours, relentless testing and an unwavering commitment to quality that saves lives and protects millions of hard working men and women each and every day. Many of our most popular products integrate multiple combinations of electronics, mechanical systems and advanced materials to help ensure that users around the world remain protected in even the most hazardous of situations.*

### Our Mission

MSA's mission is to see to it that men and women may work in safety and that they, their families and their communities may live in health throughout the world.

**MSA: Because every life has a purpose.**

Note: This Bulletin contains only a general description of the products shown. While uses and performance capabilities are described, under no circumstances shall the products be used by untrained or unqualified individuals and not until the product instructions including any warnings or cautions provided have been thoroughly read and understood. Only they contain the complete and detailed information concerning proper use and care of these products.



**ID 4600-011-MC / October 2016**  
© MSA 2016 Printed in U.S.A.

**MSA – The Safety Company**  
1000 Cranberry Woods Drive  
Cranberry Township, PA 16066 USA  
Phone 724-776-8600  
[www.MSAafety.com](http://www.MSAafety.com)

**U.S. Customer Service Center**  
Phone 1-800-MSA-2222  
Fax 1-800-967-0398

**MSA Canada**  
Phone 1-800-672-2222  
Fax 1-800-967-0398

**MSA Mexico**  
Phone 01 800 672 7222  
Fax 52 - 44 2227 3943